

ASSEMBLY INSTRUCTIONS
Gastone Tufted Upholstered Platform Bed-KB
Item#BST0379-KB

**ASSEMBLY
REQUIREMENTS**

**2-Person
Assembly**

**Assembly Time 60 Minutes
(Approximate)**

Thank you for purchasing our product!
Please refer and use this assembly instruction to assemble the product. Contact our customer service department in case there are any missing or damaged parts or hardware. Replacement parts are normally shipped within 2 or 3 days.

We appreciate your business!

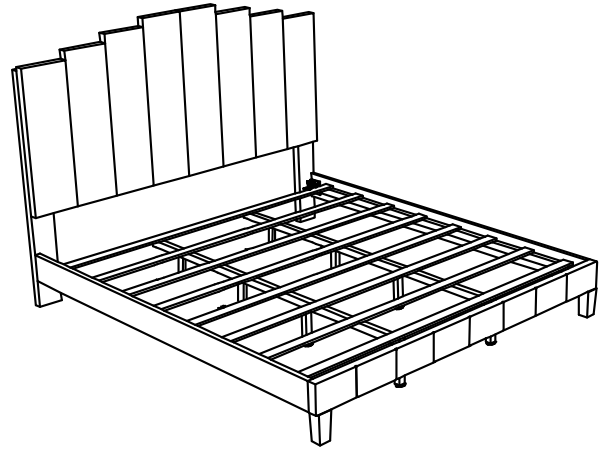

ASSEMBLY PREPARATION

1. Remove all packaging materials, staples, and packing straps from the carton.
2. Refer to Parts List and Hardware List, and ensure parts and hardware are correct before assembly.
Contact customer service for missing parts.
3. Place all wooden parts on a clean, flat, and soft surface (e.g. carpet or rug) to prevent scratch and damage to parts.

SAFETY PRECAUTION

1. Keep all hardware parts out of reach of children.
2. Dispose plastic packaging material immediately to avoid any risk of suffocation to children and animals.

TIPS FOR ASSEMBLY











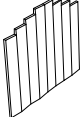

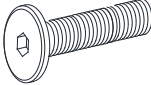

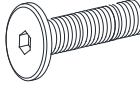

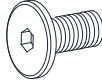
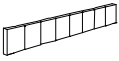
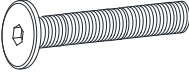
1. Allow ample room for assembly and assemble the product near where the product will be placed.
2. Assemble the product on a surface that does not scratch or damage the exterior gloss and finish of the furniture.
3. Identify all of the parts, hardware and quantities required for each step.
4. During assembly, do not over-tighten any fittings as this may cause damage.
5. Do not use power tools to assemble this product.
6. Always place the product on a flat, level surface.
7. Do not sit or stand on the partially assembled product; only use the product for which it is intended.

CARE AND MAINTENANCE

1. Use a slightly damp cloth to clean the product. Do not use bleach or abrasive cleaning material.
2. Check all the fittings periodically and re-tighten as necessary. Do not use the product if any of the parts is damaged or broken.
3. Never allow any kind of liquid to remain on your furniture. Absorption can cause wood to warp or delaminate.
4. Do not drag and/or pull the furniture.

This product is for indoor and household use only - not for commercial use.

ASSEMBLY INSTRUCTIONS
Gastone Tufted Upholstered Platform Bed-KB
Item#BST0379-KB

NO	PART LIST	QTY	NO	HARDWARE	QTY
1	 HEADBOARD PANELS	8PCS	A	 ALLEN KEY	1PC
2	 CAP FOR UPPER HB	2PCS	B	 BOLT 5/16*45	4PCS
3	 HEADBOARD LEGS	2PCS	C	 BOLT 5/16*35	16PCS
4	 SIDERAILS (L/R)	2PCS	D	 BOLT 5/16*25	8PCS
5	 FOOTBOARD CUSHION	1PC	E	 BOLT 1/4*60	8PCS
6	 SLATS	8PCS	F	 FLAT WASHER 5/16	28PCS
7	 CENTER SUPPORT BAR	2PCS	G	 FLAT WASHER 1/4	8PCS
8	 FOOTBOARD LEGS	2PCS	H	 SPRING WASHER 5/16	28PCS
9	 CENTER SUPPORT LEGS (With adjustable feet)	8PCS	I	 SPRING WASHER 1/4	8PCS
			K	 SCREW F4x30	32PCS

STEP 1

Turn the panels upside down if there's color variation with the rest of the panels. Make sure the holes will line up in step 2.

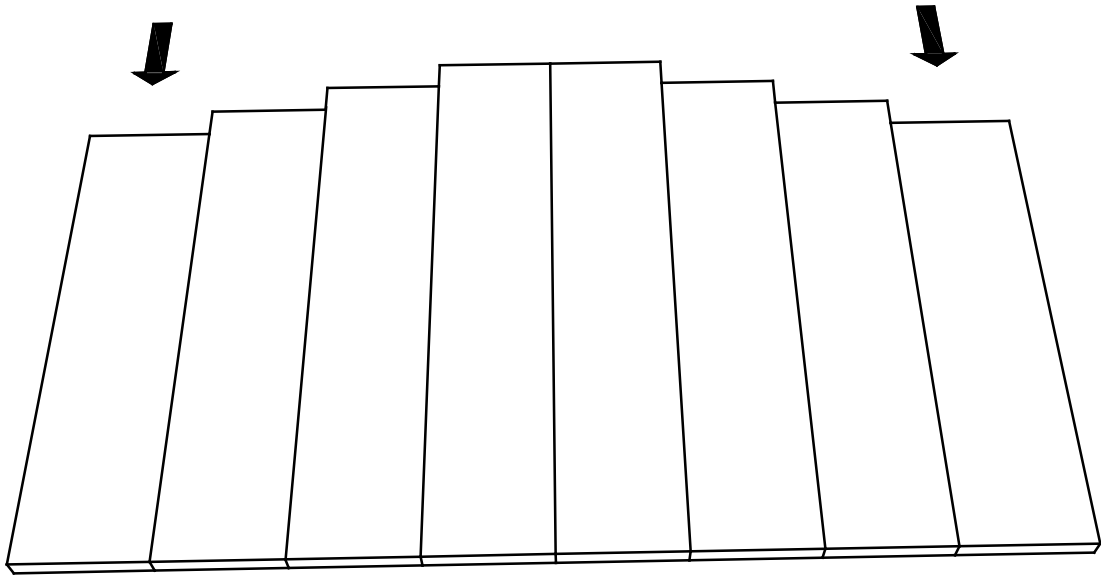

- A. Lay all of the upholstered panels on a clean dry surface flat in a row with the front side facing up so they look as they will on the headboard in the order as shown above.
- B. Examine the panels to be sure that they are in the proper order and that the color matches and looks appropriate. Note: Due to the nature of this fabric, there may be color variation between first and last piece of the panels with the rest of the panels. You may need to turn the first and last panels upside down to get the color to be uniform.

STEP 2

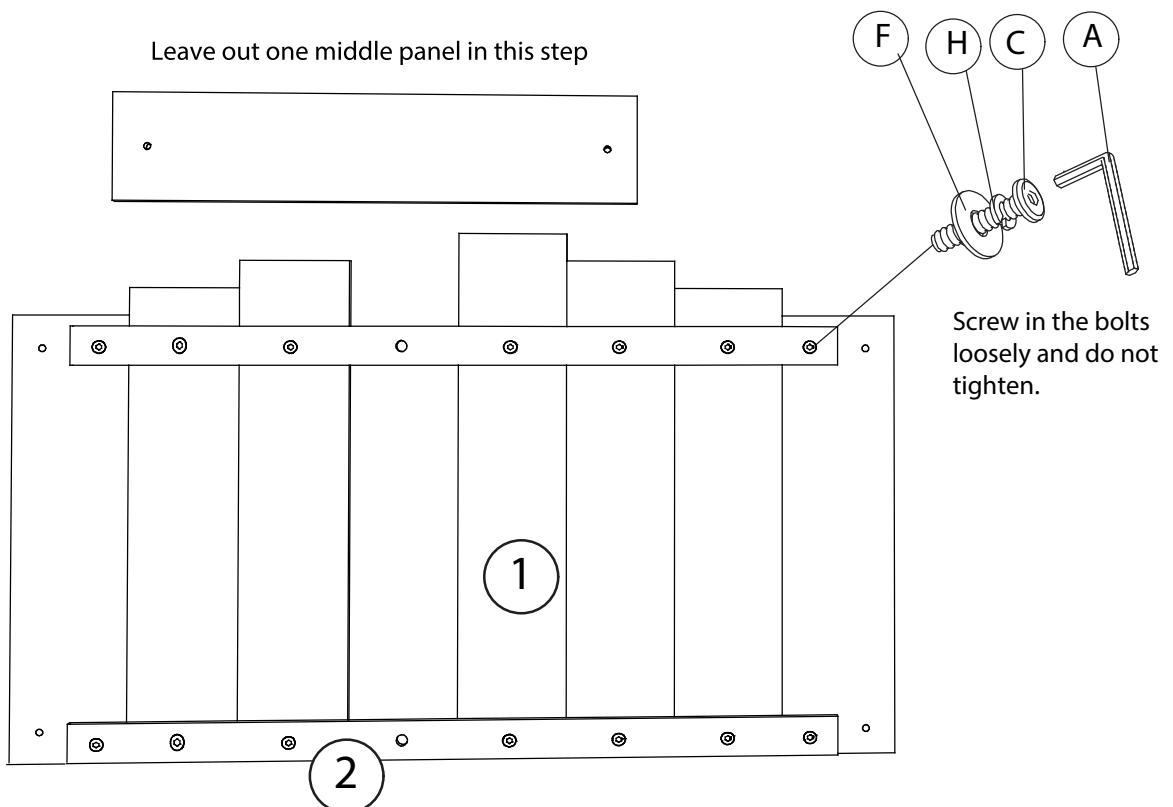

- A. Flip over the panels and leave out a middle panel.
- B. Fasten Caps(2) to the panels(1) with Bolts(C) fitted with Spring Washer(H) and Flat Washer(F).

STEP 3

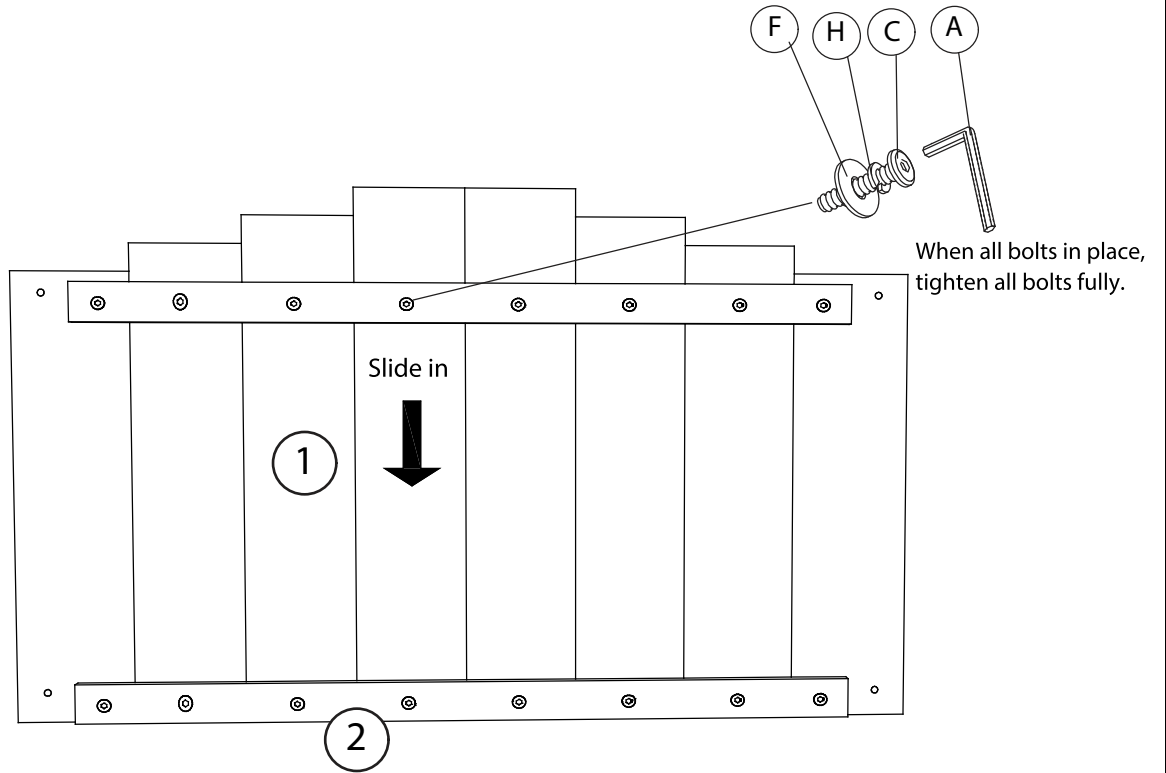

- A. When all bolts are in place, slide in the middle panel and attach Bolts(C), Spring Washer(H) and Flat Washer(F).
- B. When all bolts are in place, tighten all bolts fully.

STEP 4

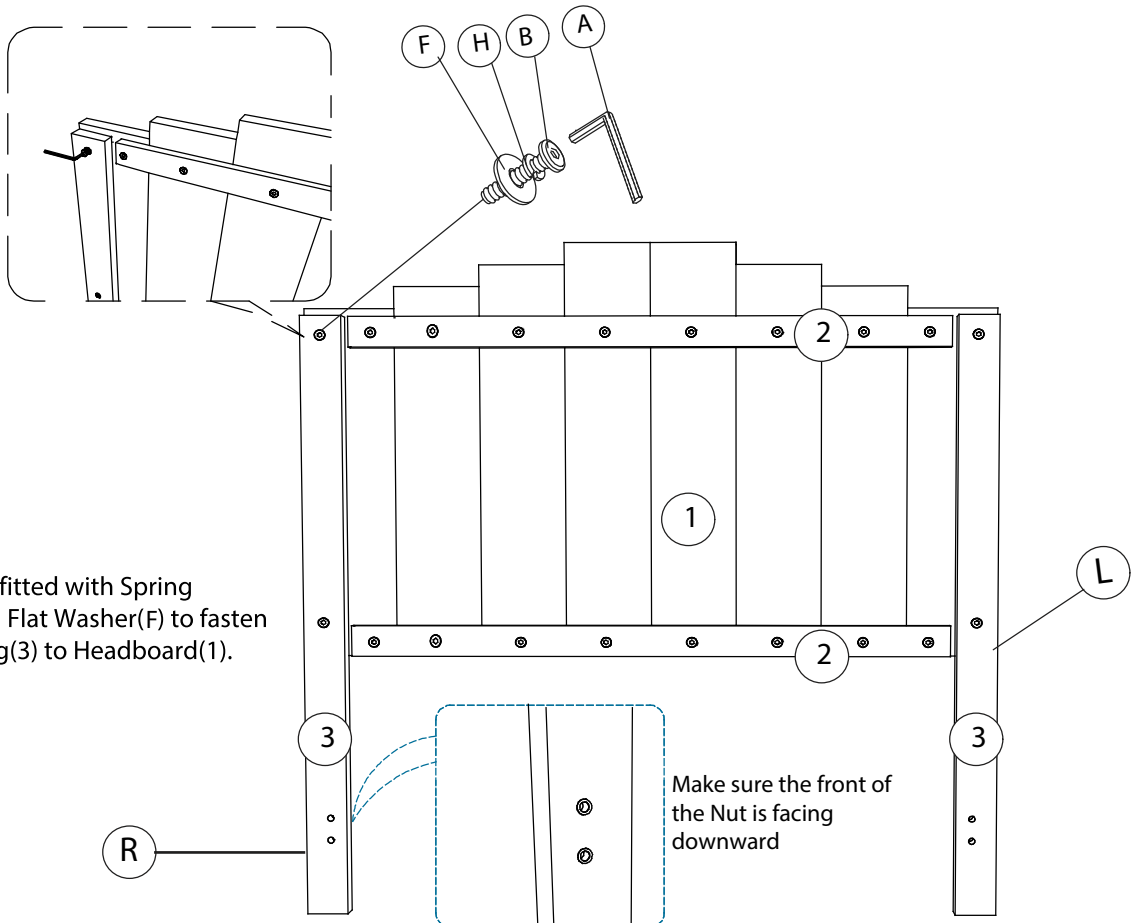

- A. Use Bolt(B) fitted with Spring Washer(H) and Flat Washer(F) to fasten Headboard Leg(3) to Headboard(1).

STEP 5

STEP 5.1

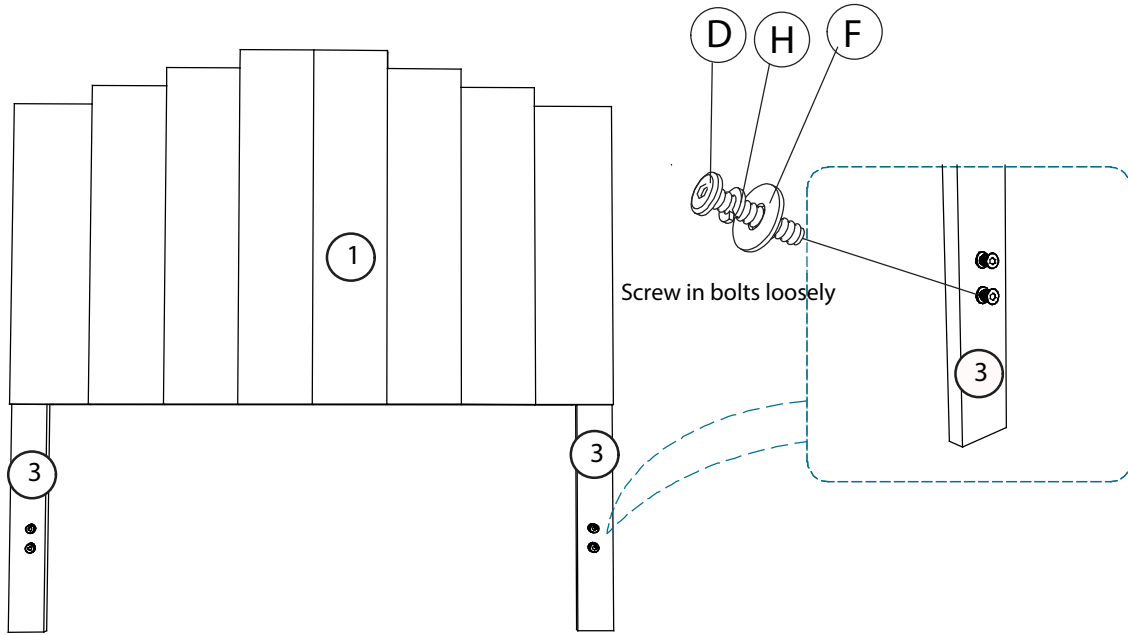

A. Use Allen Key(A) to drive and loosely screw in Bolt(D) fitted with Spring Washer(H) and Flat Washer(F) onto the Headboard Leg(3)

STEP 5.2

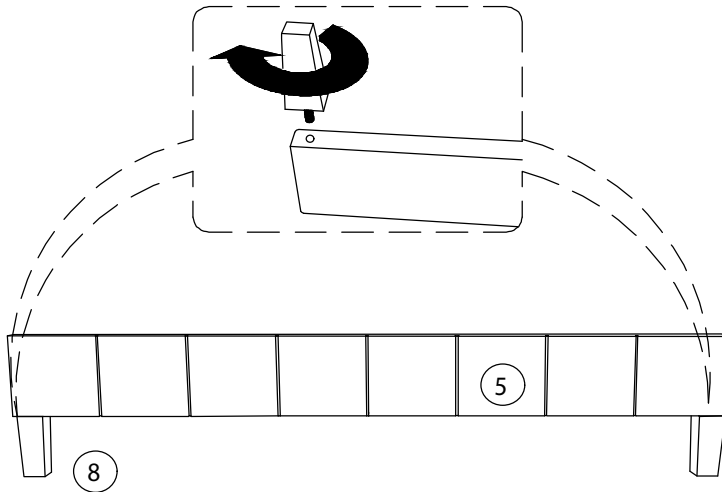

A. Screw in Footboard Leg(8) to Footboard(5).

STEP 5.3

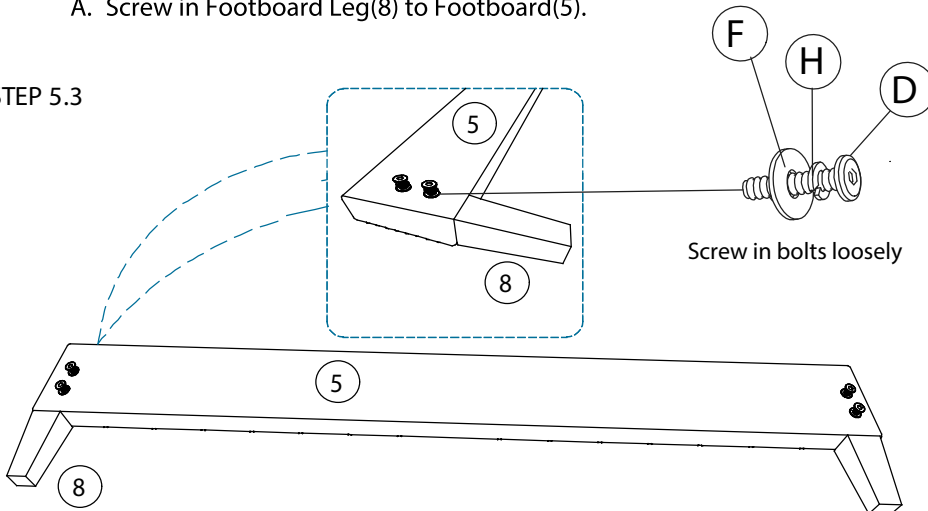

A. Use Allen Key(A) to drive and loosely screw in Bolt(D) fitted with Spring Washer(H) and Flat Washer(F) onto the Footboard(5).

STEP 6

STEP 6.1

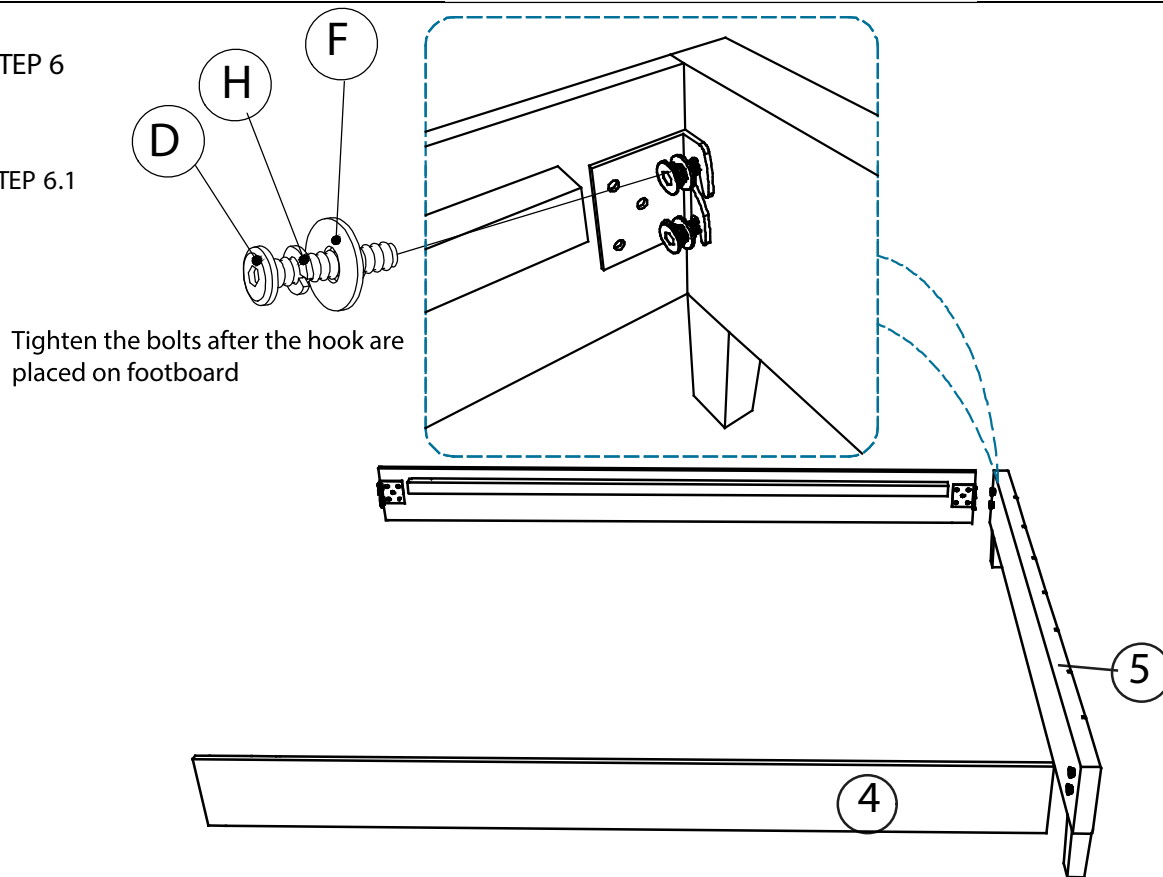

A. Place the hook on Side Rail(4) to the bolt(D) on Footboard(5). Tighten the bolts fully.

STEP 6.2

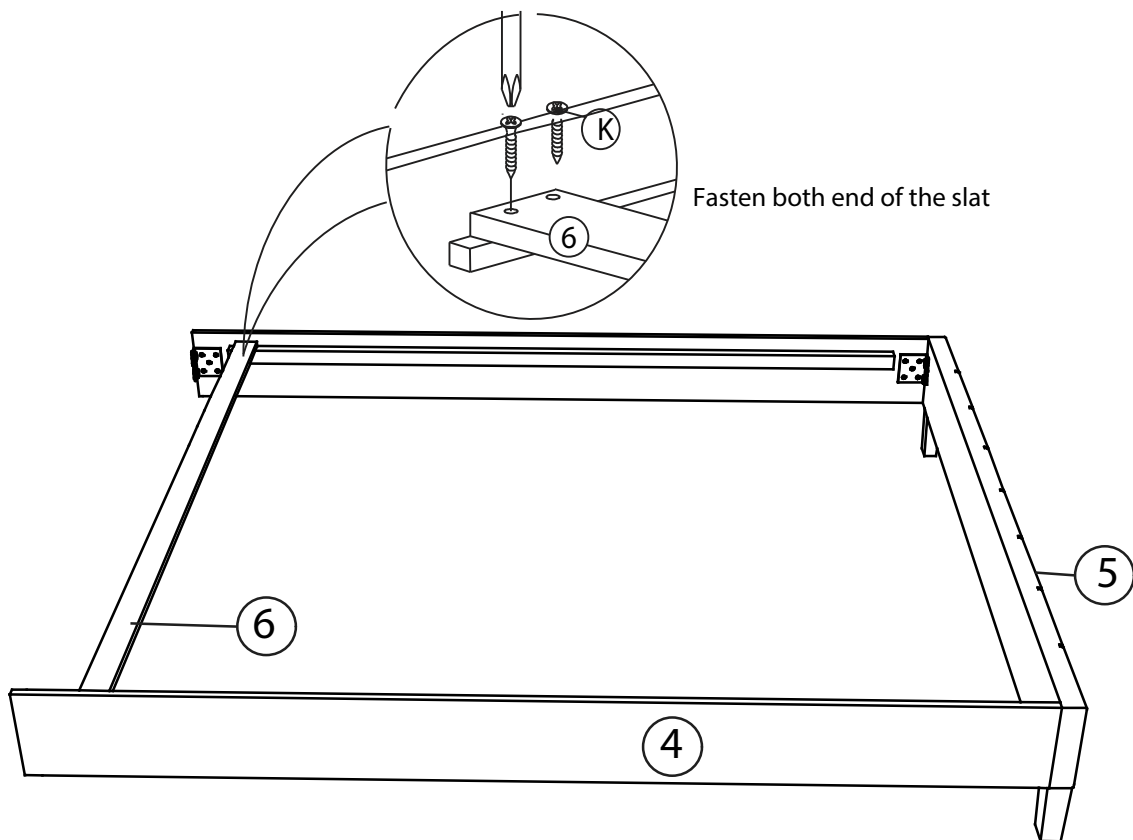

A. Use Screw(K) to fasten one slat(6) at the front side of the SideRail(4) as shown above.

STEP 7

Tighten the bolts after the hook are placed on headboard

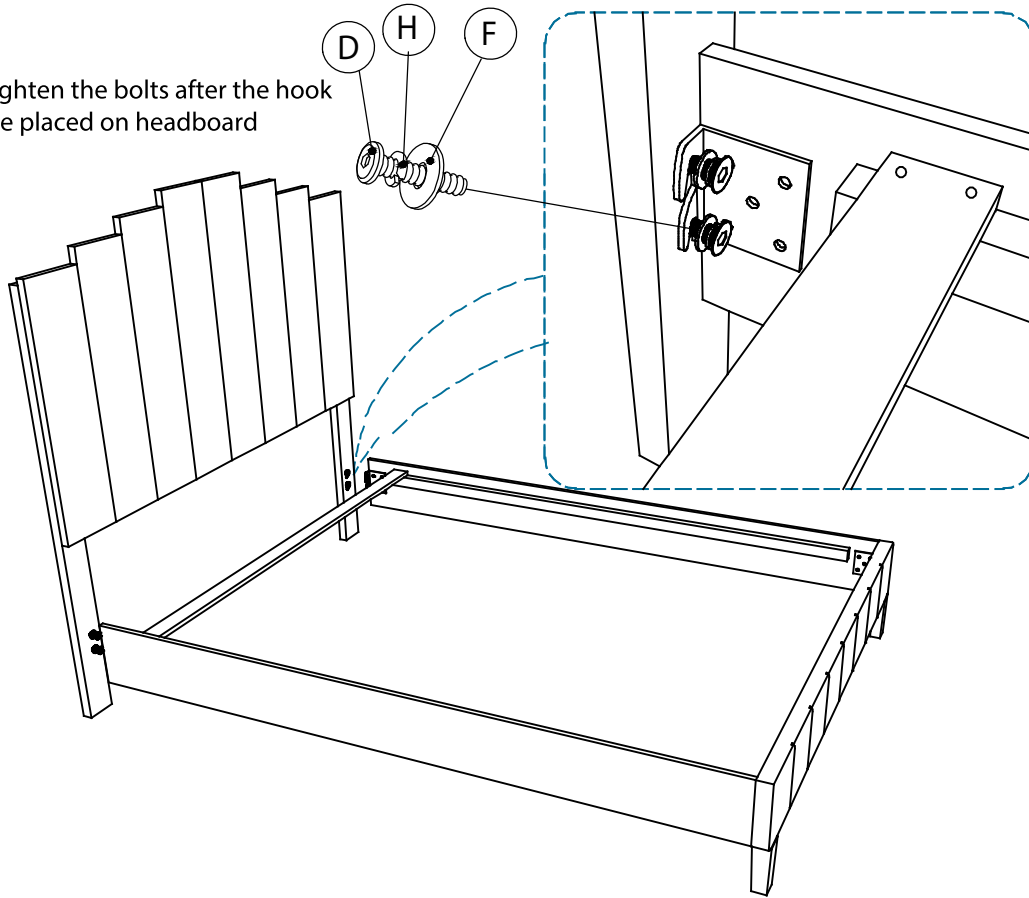

A. Place the hook on SideRail(4) to the bolts(D) on Headboard Leg(3) as shown above.

STEP 8

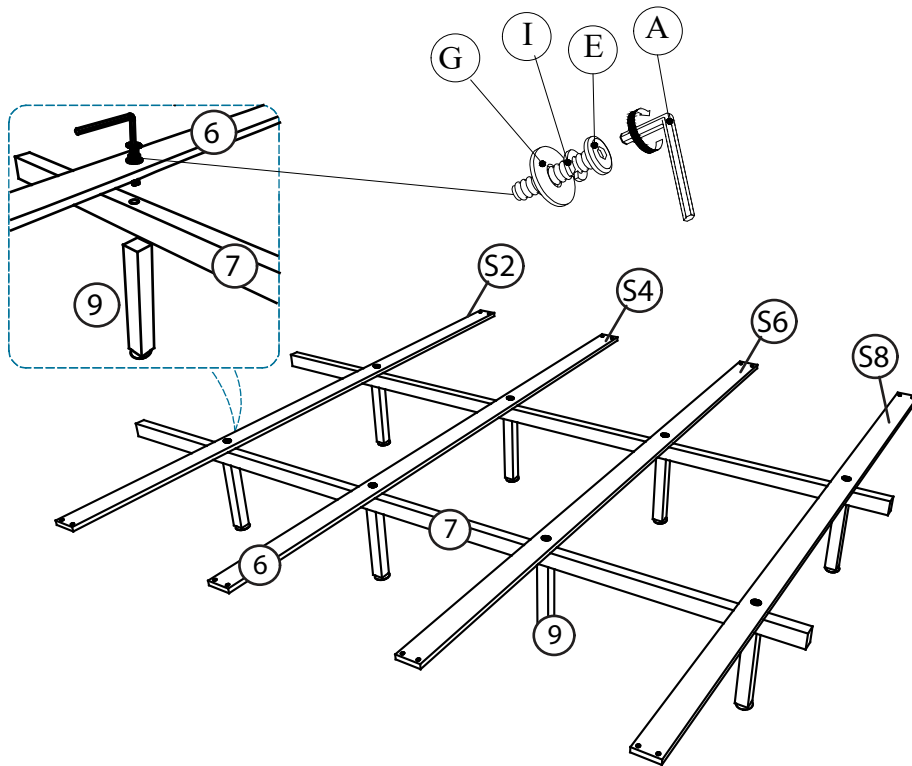

A. With assistance, use Bolt(E) fitted with Spring Washer(I) and Flat Washer(G) to attach 4 pieces of Slats(6) denoted as S2, S4, S6 & S8, to the Center Support Bar(7) and Center Support Leg(9) as shown above.

STEP 9

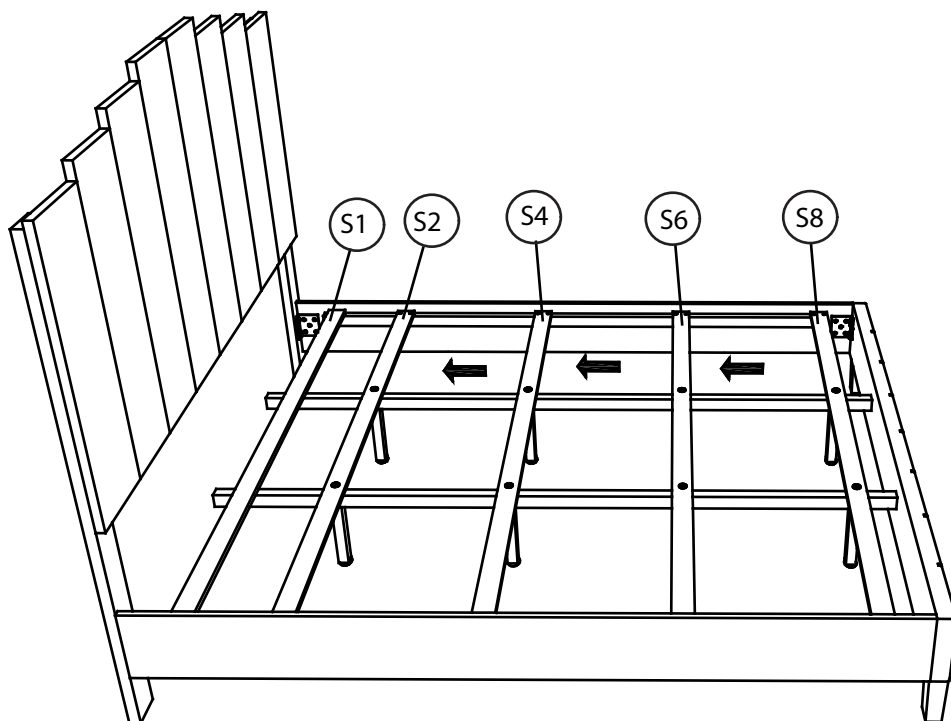

A. Place the assembled slats on the Side Rail(4). Slide in the Center Support Bar(7) underneath the first slat as shown above.

STEP 10

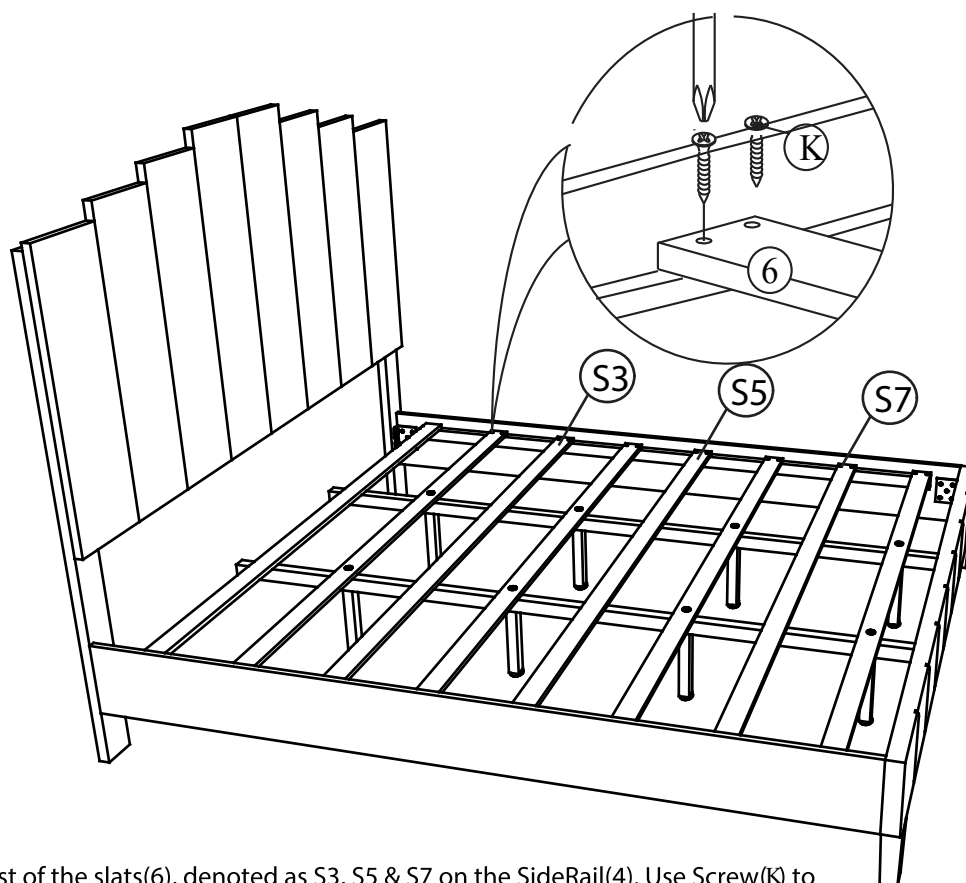

A. Place the rest of the slats(6), denoted as S3, S5 & S7 on the SideRail(4). Use Screw(K) to fasten all the slats(6).

THE ASSEMBLY OF THE BED IS COMPLETE.