

ASSEMBLY INTRUCSION

BED

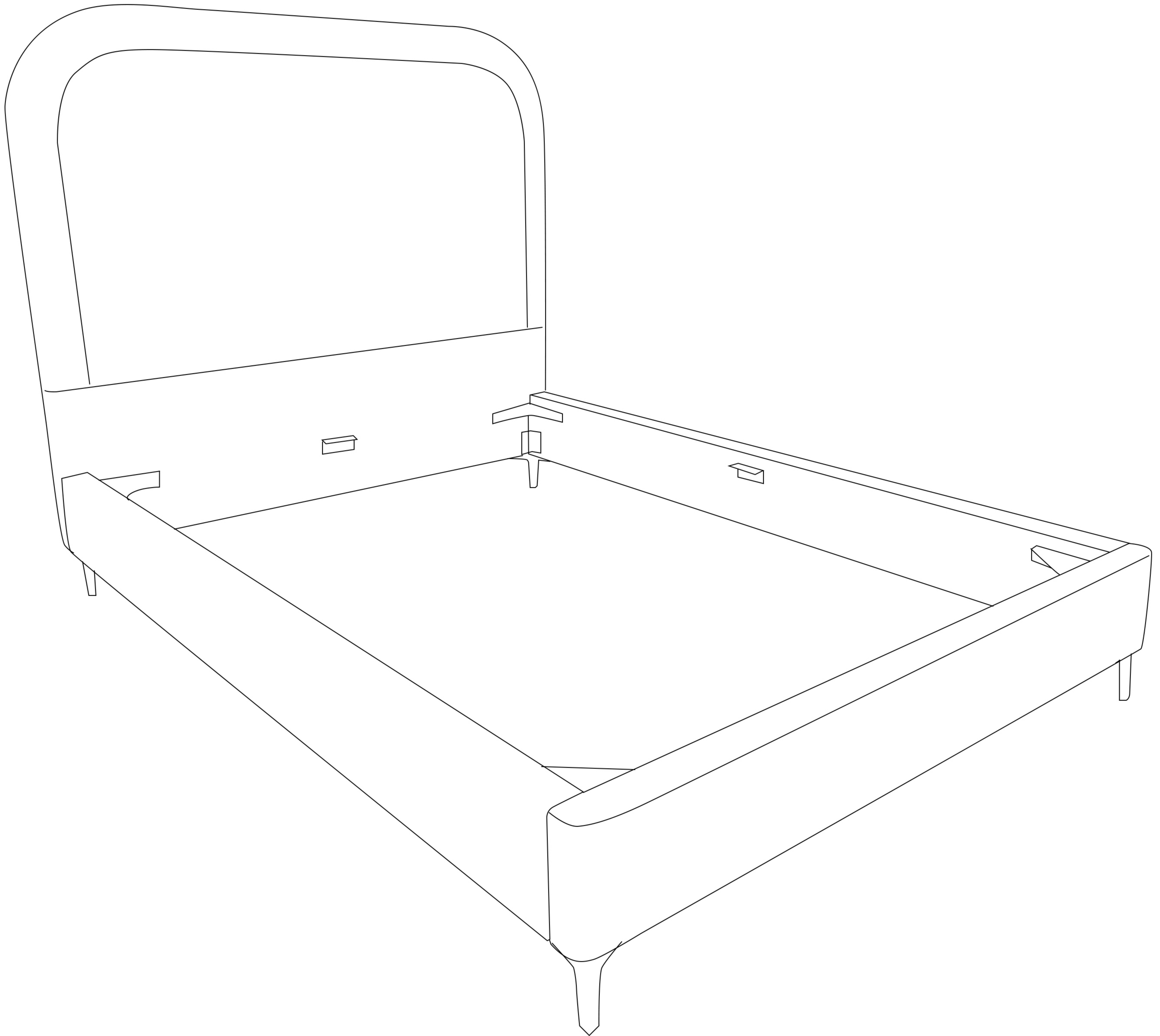

IMPORTANT NOTE

1. PLACE ALL PARTS ON A CLEAN AND SMOOTH SURFACE SUCH AS A RUG OR CARPET TO AVOID THE PARTS FROM BEING SCRATCHED
2. BEFORE YOU BEGIN, KINGLY FOLLOW THE ASSEMBLY INSTRUCTIONS STEP BY STEP
3. DO NOT TIGHTEN ALL SCREWS AND BOLTS IUNTIL THE BED IS FULLY SET-YP

Part list BOX 1:

M

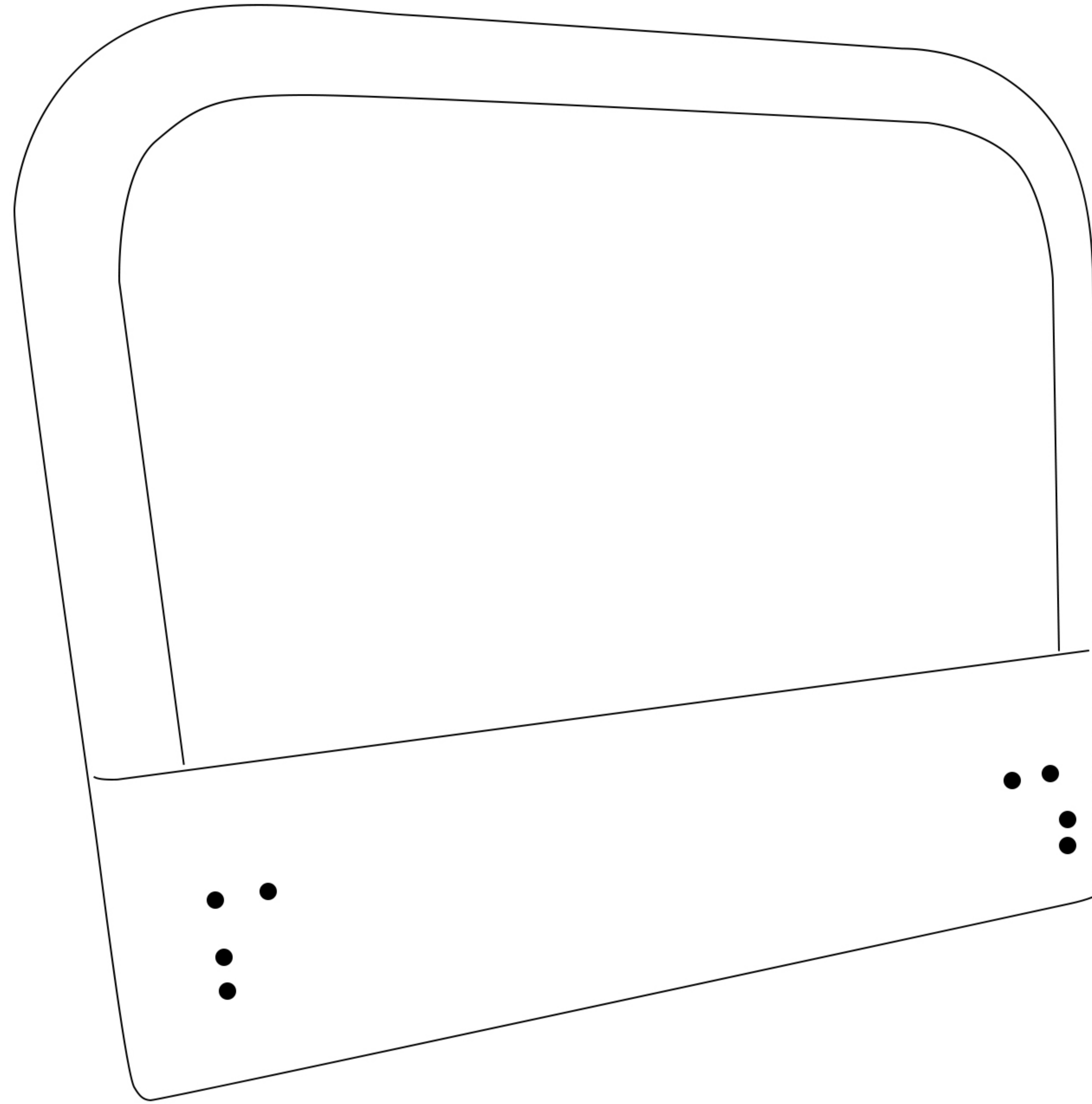

BEDHEA - (1 pcs)

G

PART LIST BC X 2:

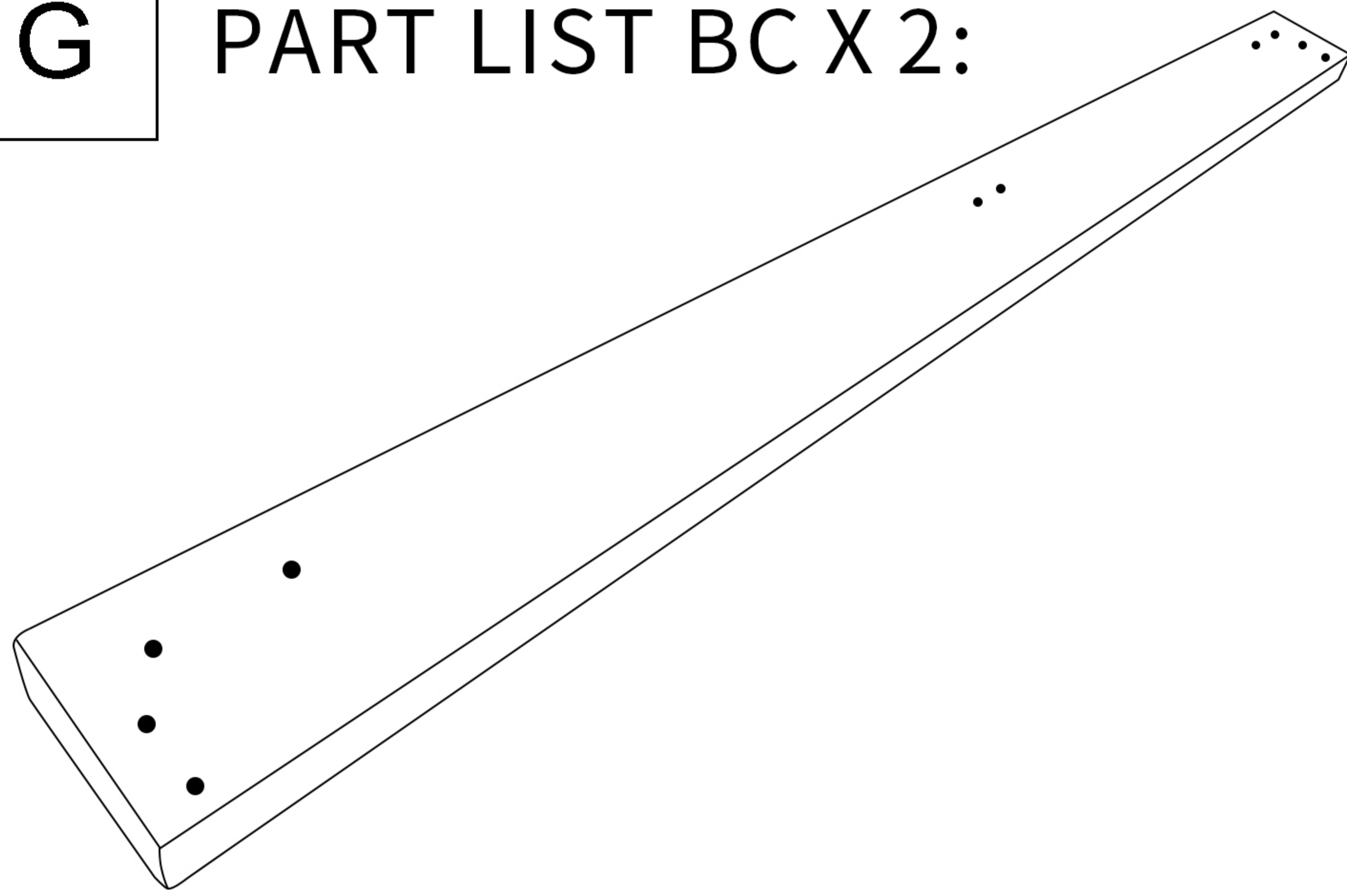

BEDSIDE - (2 pcs)

H

PART LIST BC X 2:

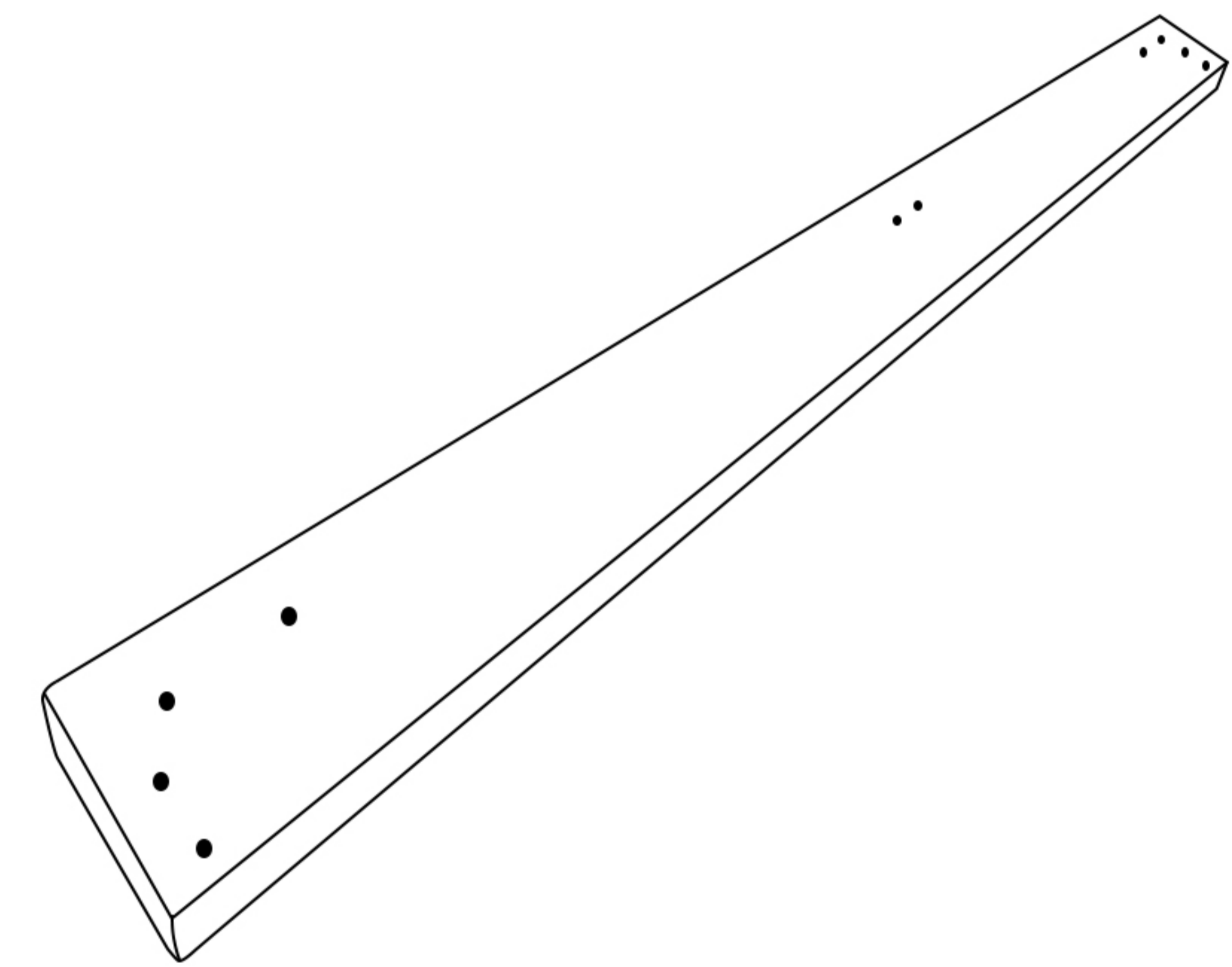

BED TAIL - (1 pcs)







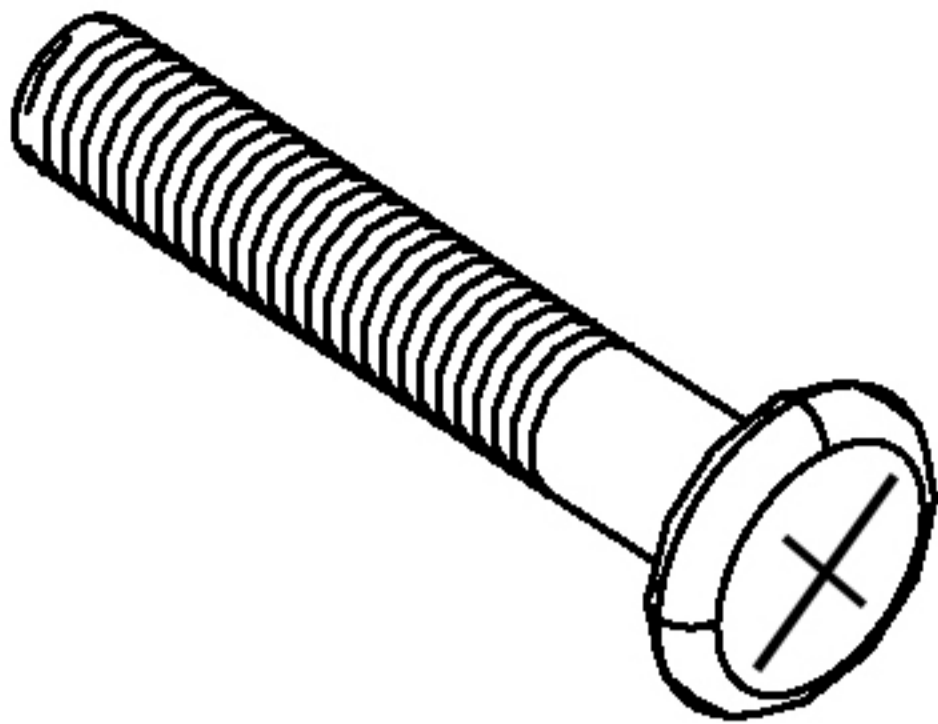
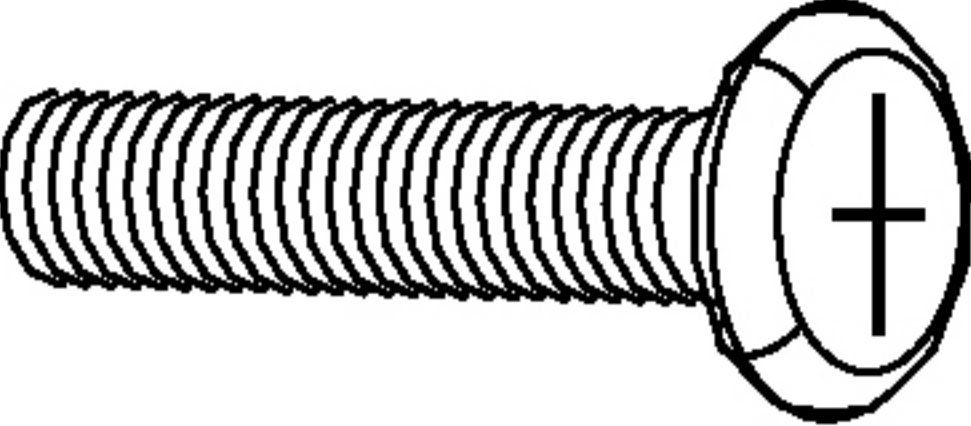
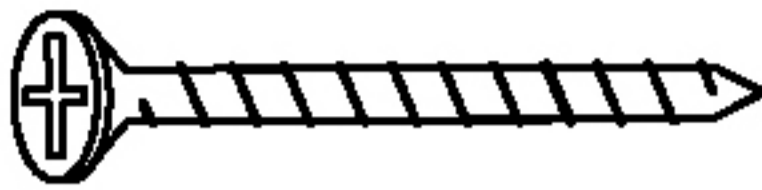
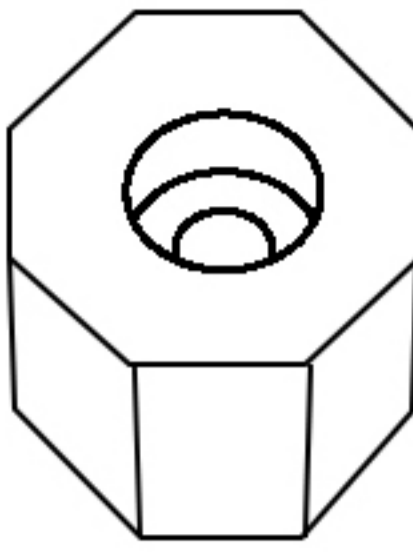

P

PART LIST BC X 3:



BED RACK FRAMEWORKDE - (1 pcs)

Hardware list

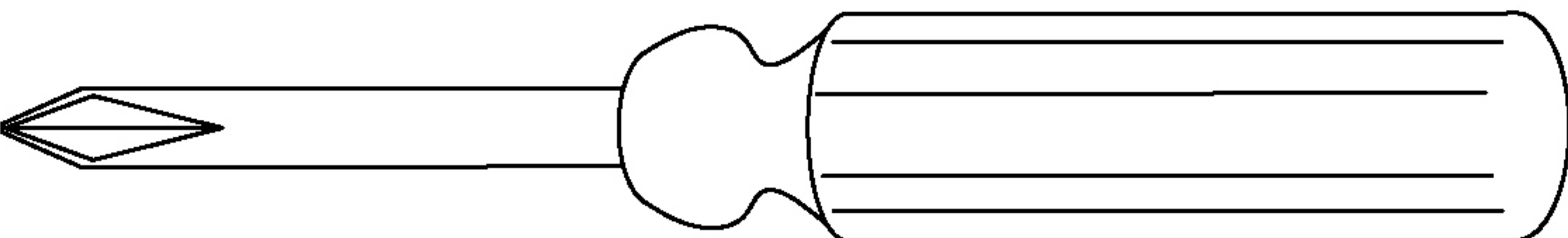
<p>1</p>  <p>1/4" x 50 mm Hex head bolts - 6 pcs</p>	<p>2</p>  <p>1/4" x 25 mm Hex head bolts - 40 pcs</p>	<p>3</p>  <p>m4 x 25 Wood screws - 12 pcs</p>	<p>4</p>  <p>connecting bar - 4 pcs</p>
<p>5</p>  <p>Ø25X3mm Mute pad-10 pcs</p>	<p>6</p>  <p>41X99mm CORNER BRACE-4 pcs</p>	<p>7</p>  <p>52X75mm CORNER BRACE-4 pcs</p>	<p>8</p>  <p>40X175mm CORNER BRACE-4 pcs</p>
<p>9</p>  <p>131X111mm BED FOOT-4 pcs</p>	<p>10</p>  <p>111X197-330mm ADJUSTER FOOT-2 pcs</p>	<p>11</p>  <p>45X197-330mm ADJUSTER FOOT-2 pcs</p>	<p>12</p>
<p>13</p>	<p>14</p>	<p>15</p>	<p>16</p>
<p>17</p>  <p>Assemble tools required (Not included)</p>			

PS:BEDHEAD AGAINST WALL

Step 1

1. AS SHOWN IN THE FIGURE, PLACE THE BED HEAD, BED FAIRY, BED TAIL, AND CORRESPONDING HARDWARE ACCESSORIES PROPERLY

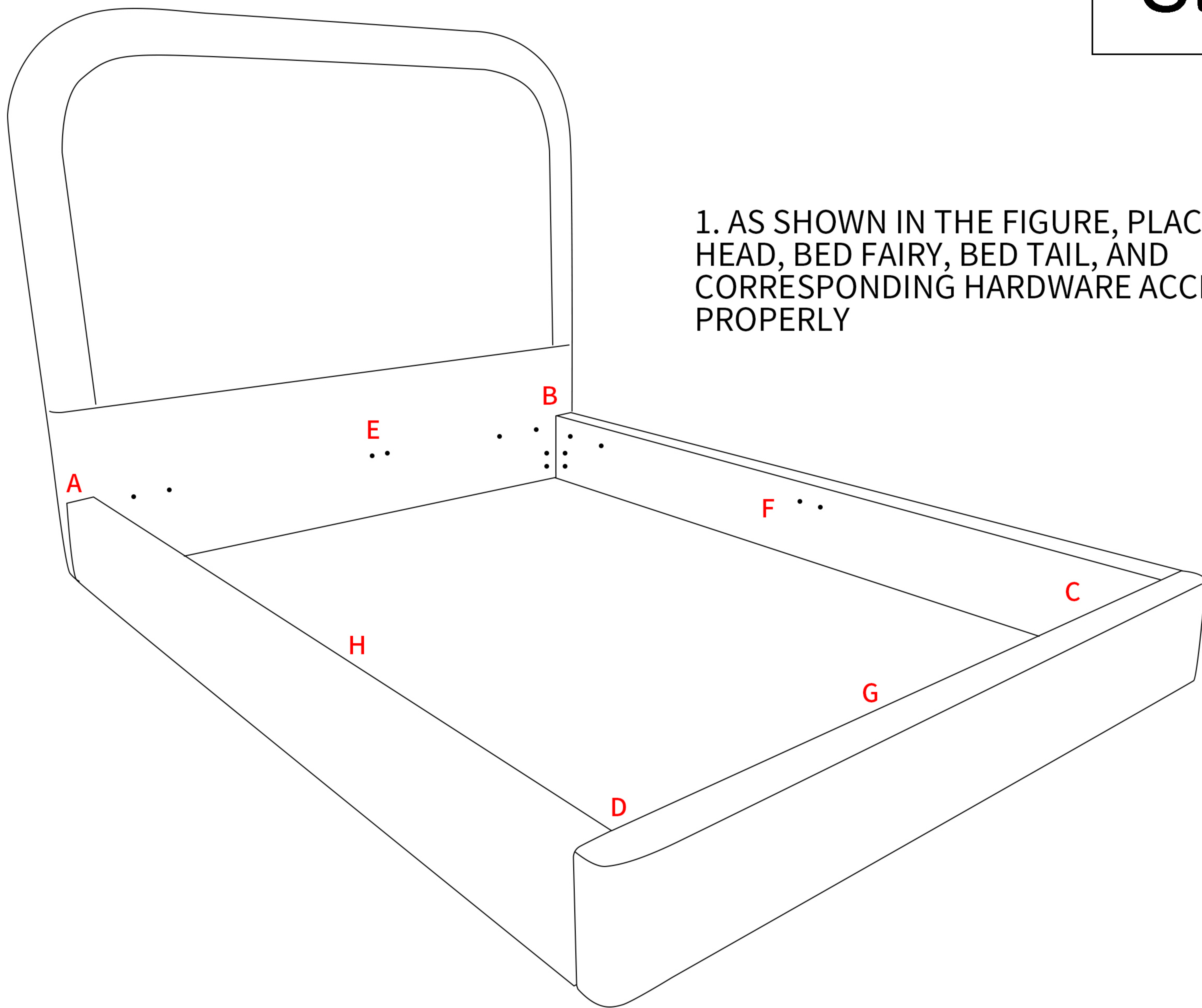

Step 2

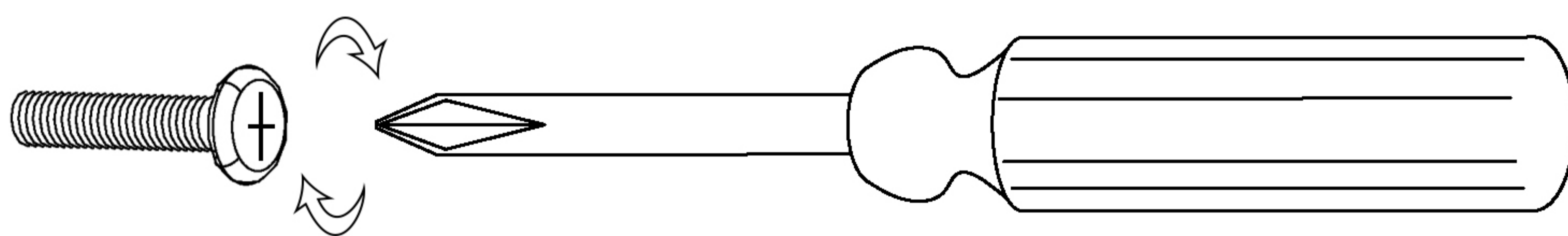

2

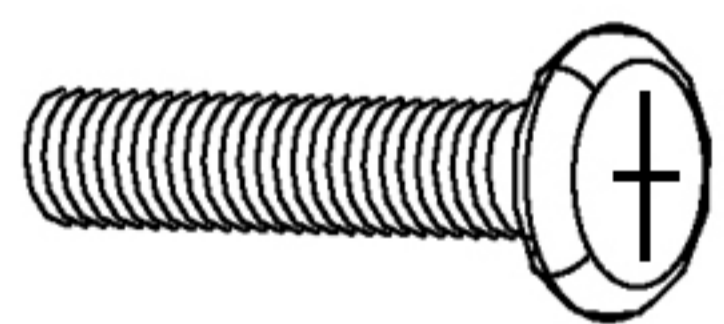

1/4" x 25 mm
Hex head bolts - 16 pcs

7



52X75mm
CORNER BRACE-2 pcs

8

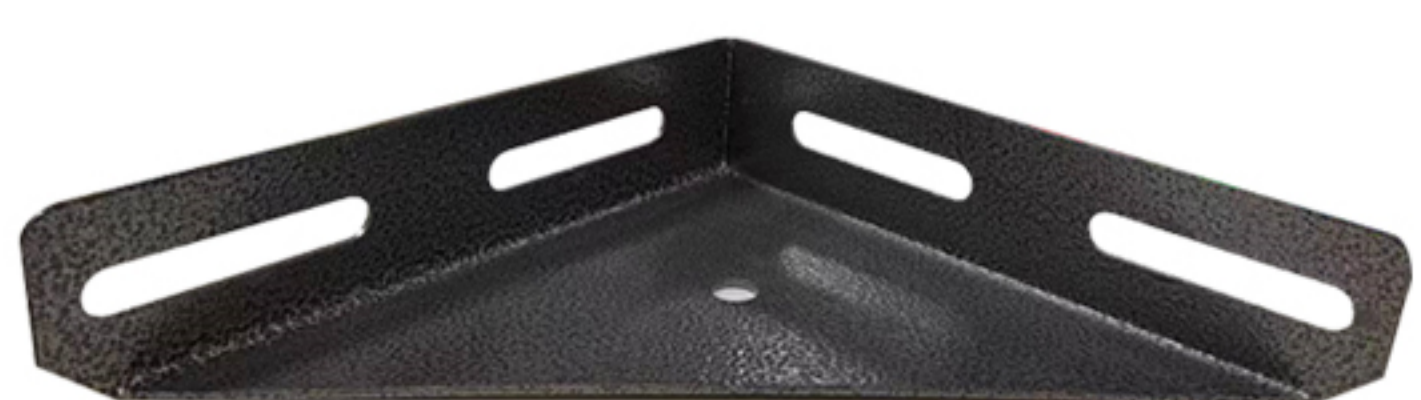

40X175mm
CORNER BRACE-2 pcs

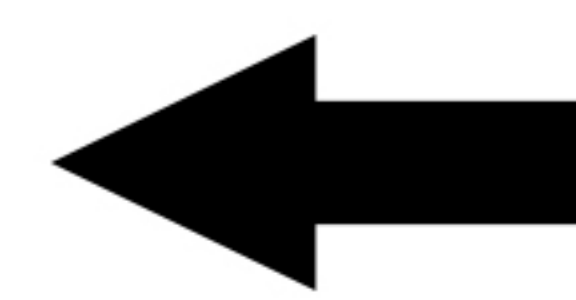
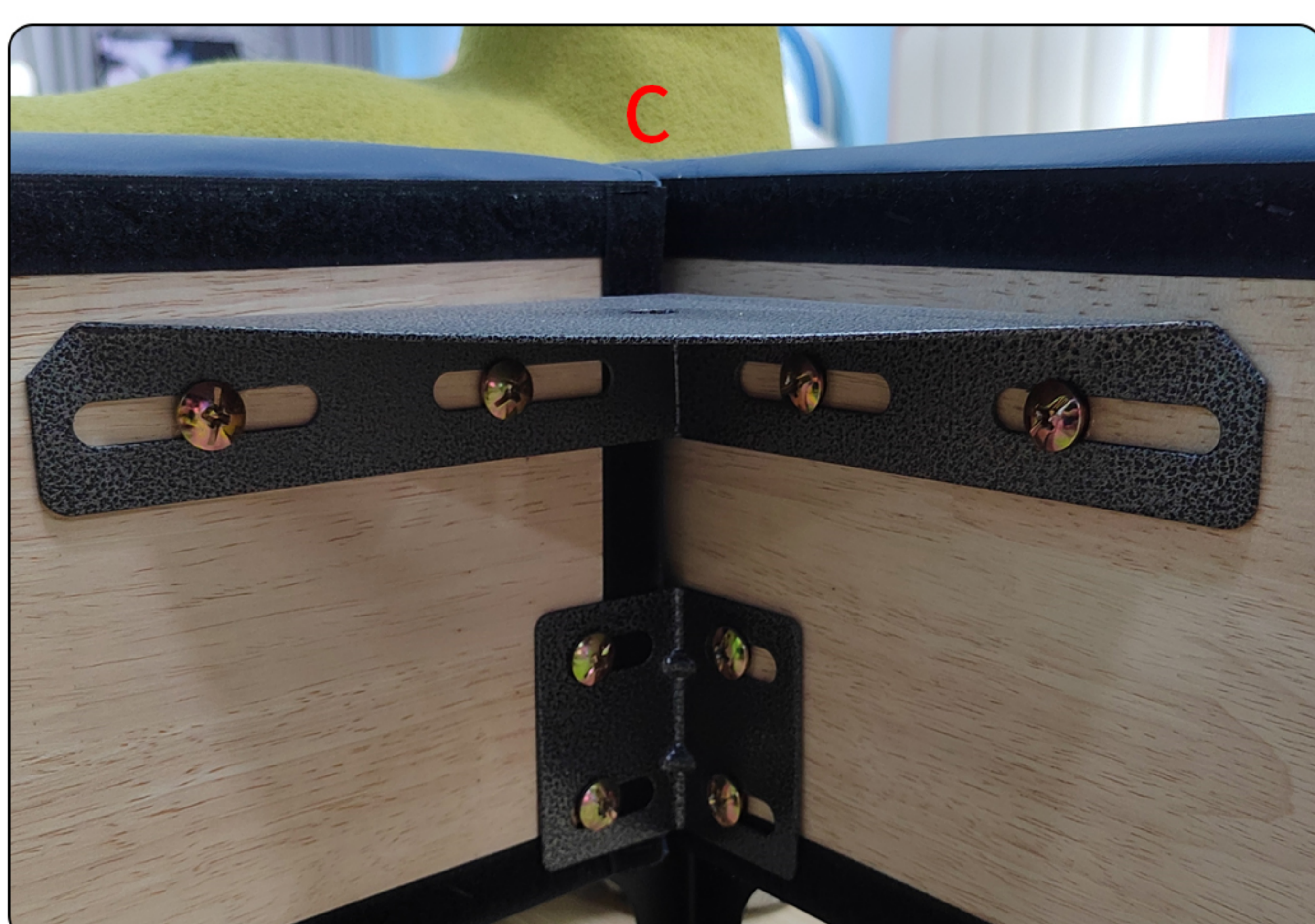
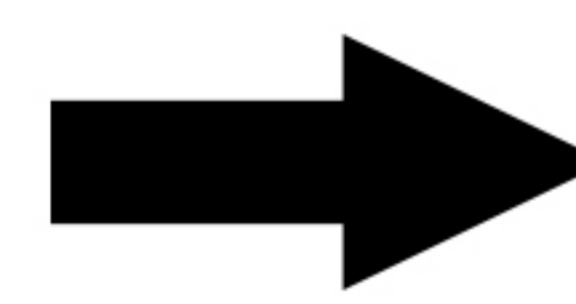

Step 3

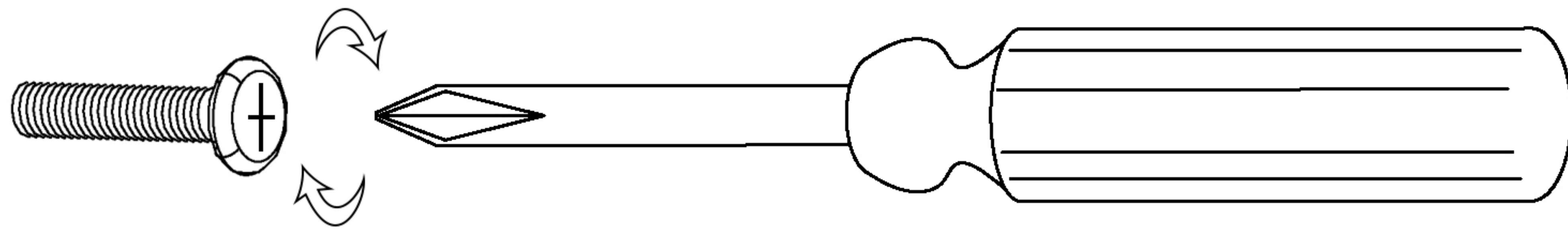

2

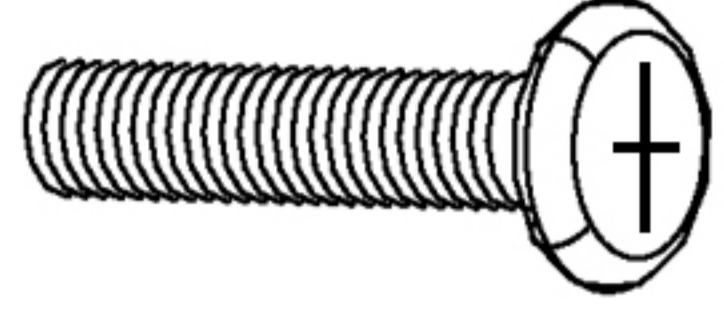

1/4" x 25 mm
Hex head bolts - 16 pcs

7



52X75mm
CORNER BRACE-2 pcs

8



40X175mm
CORNER BRACE-2 pcs

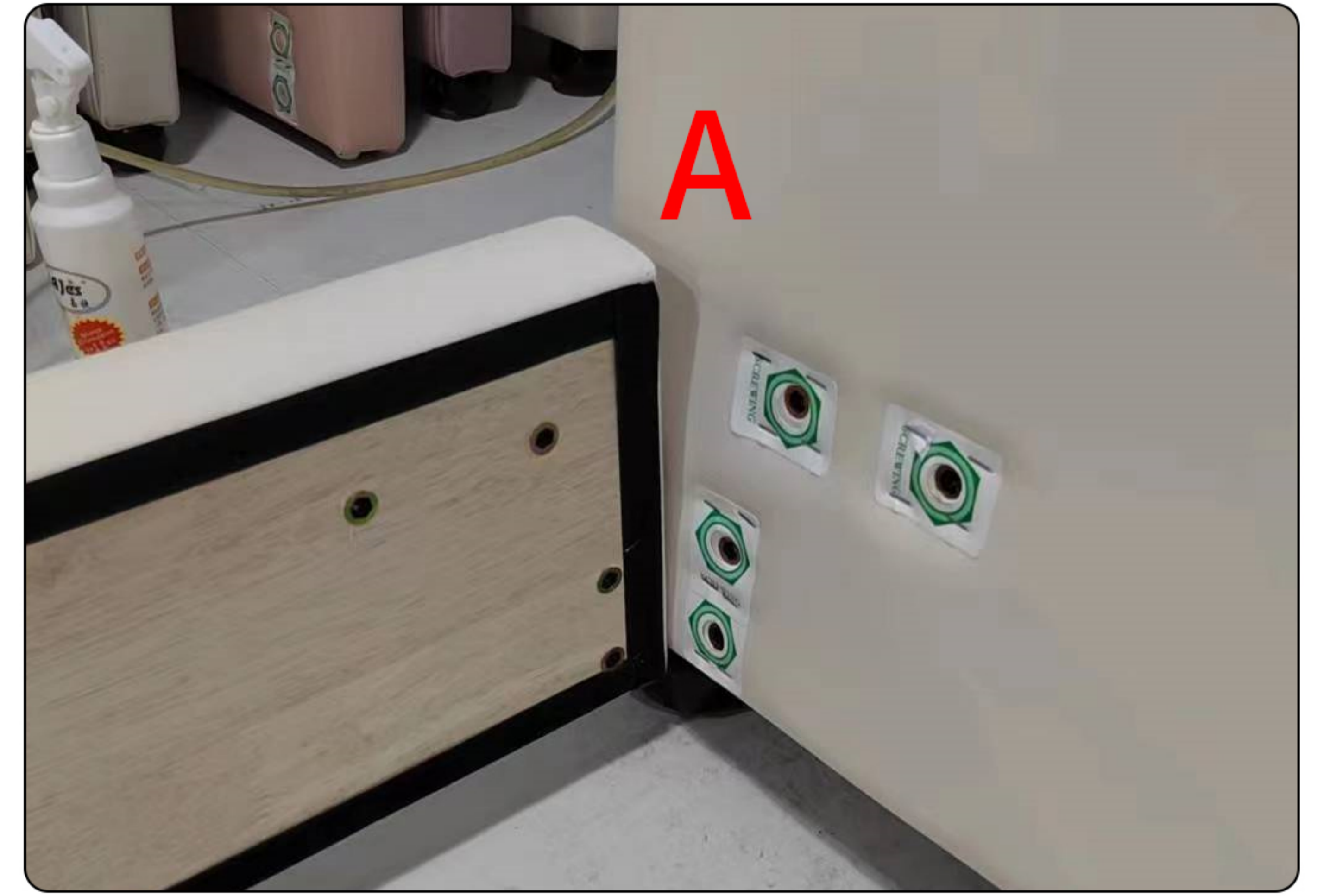
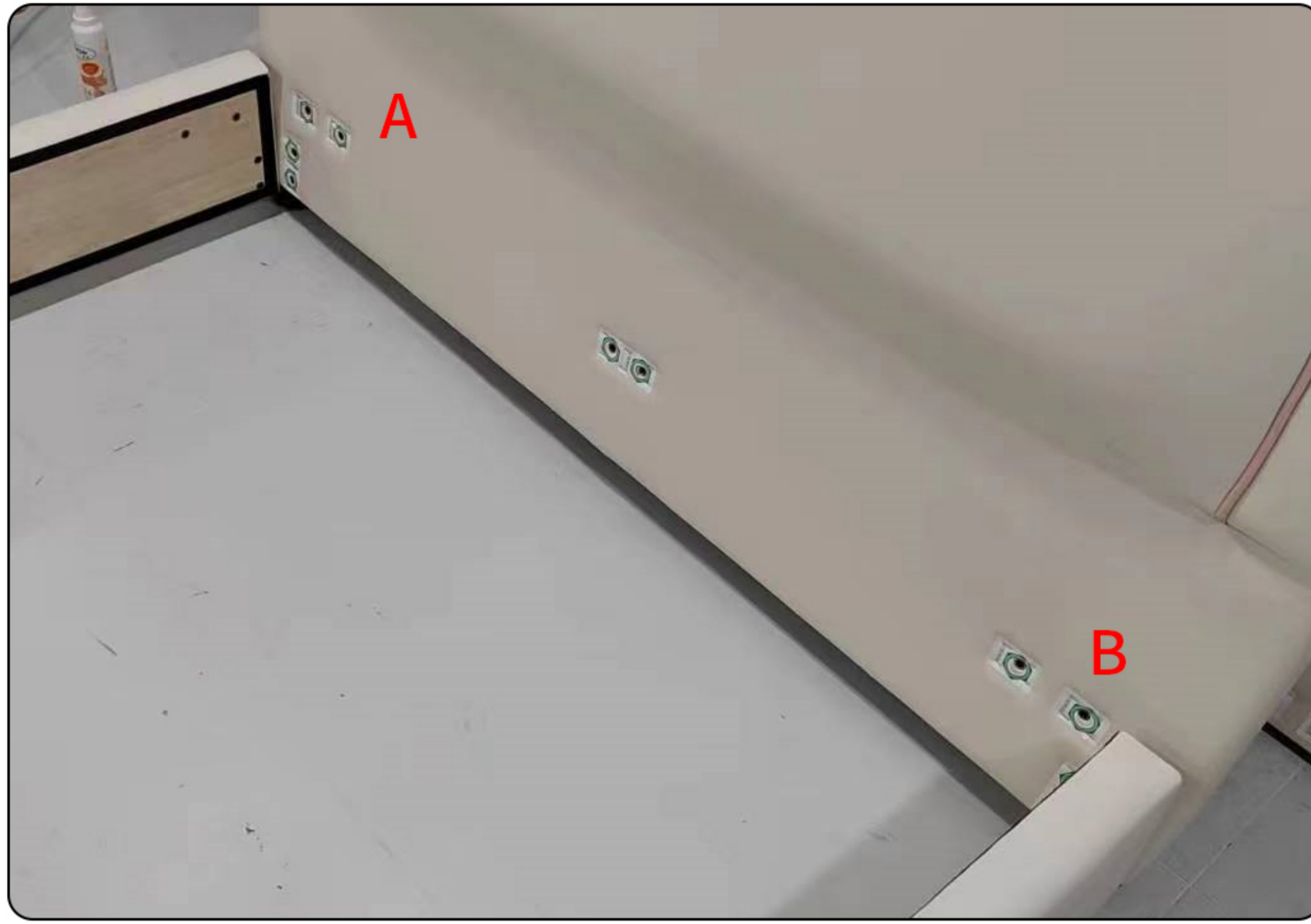

Step 4

2

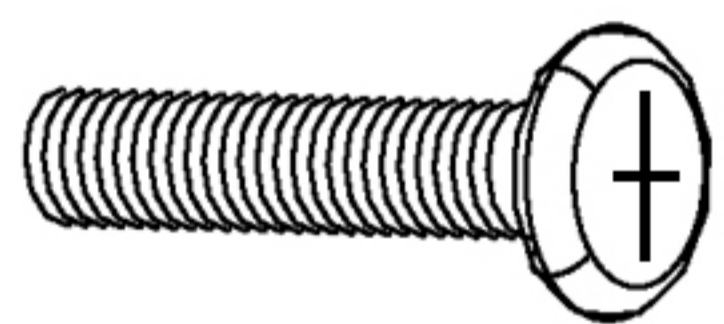

1/4" x 25 mm
Hex head bolts - 8 pcs

6



41X99MM
CORNER BRACE-4 pcs

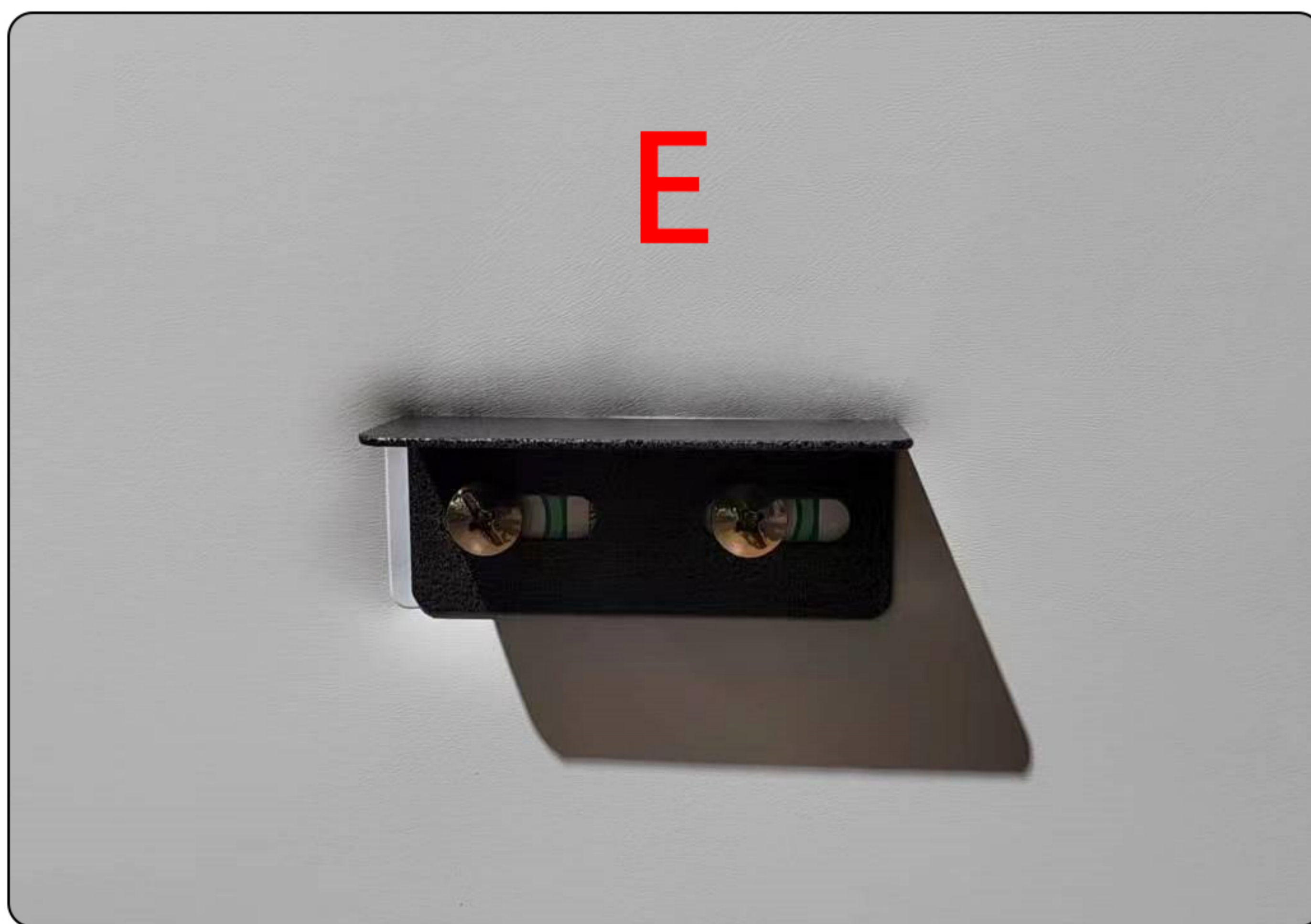

Step 5

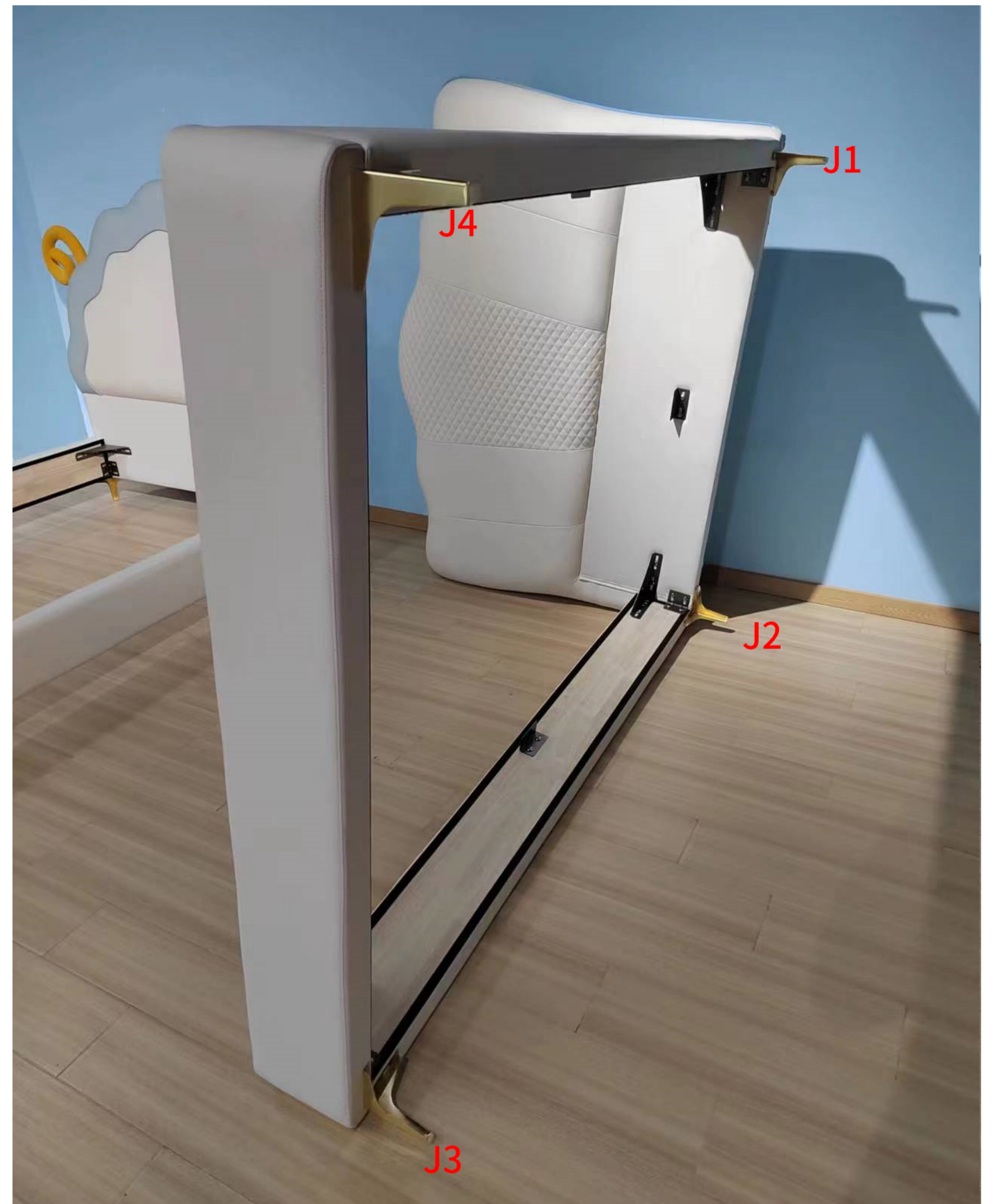
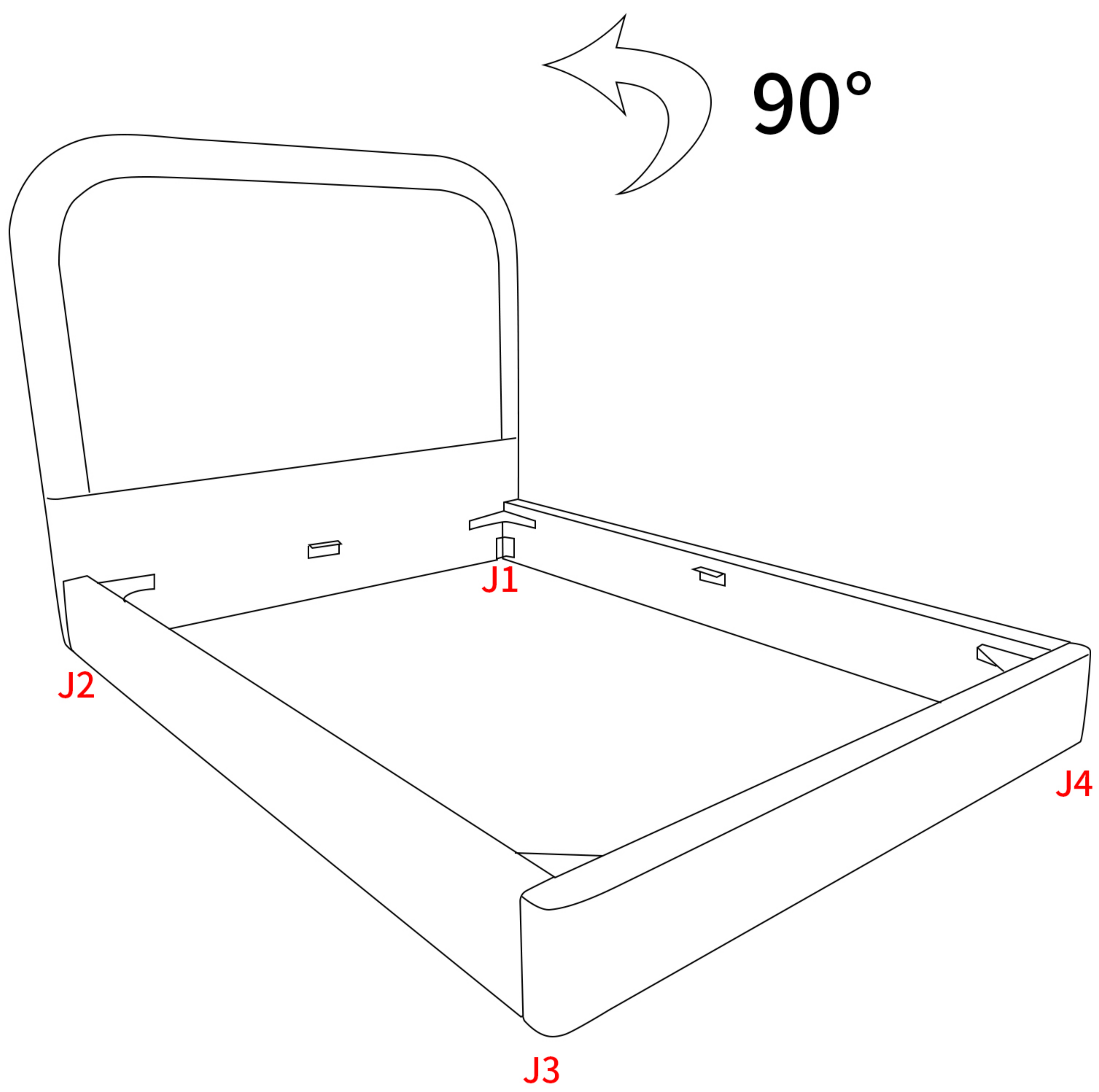

Step 6

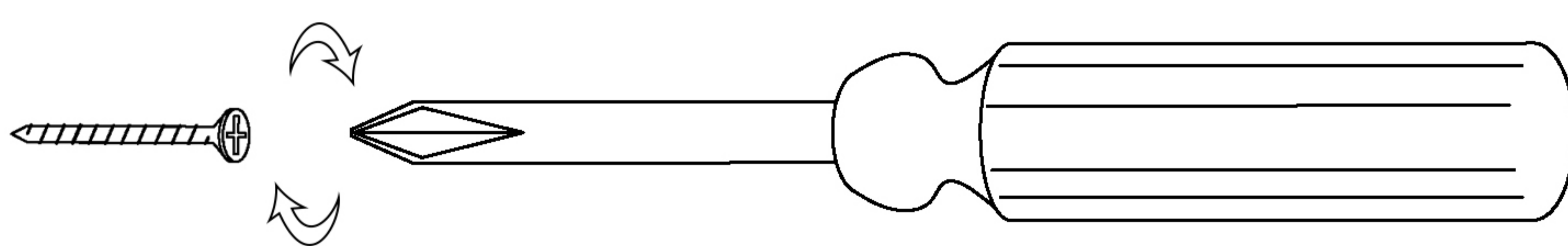

2

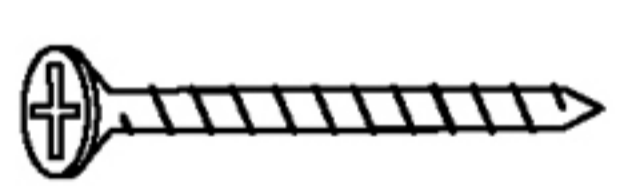

m4 x 25
Wood screws - 12 pcs

9



131X111mm
BED FOOT-4 pcs

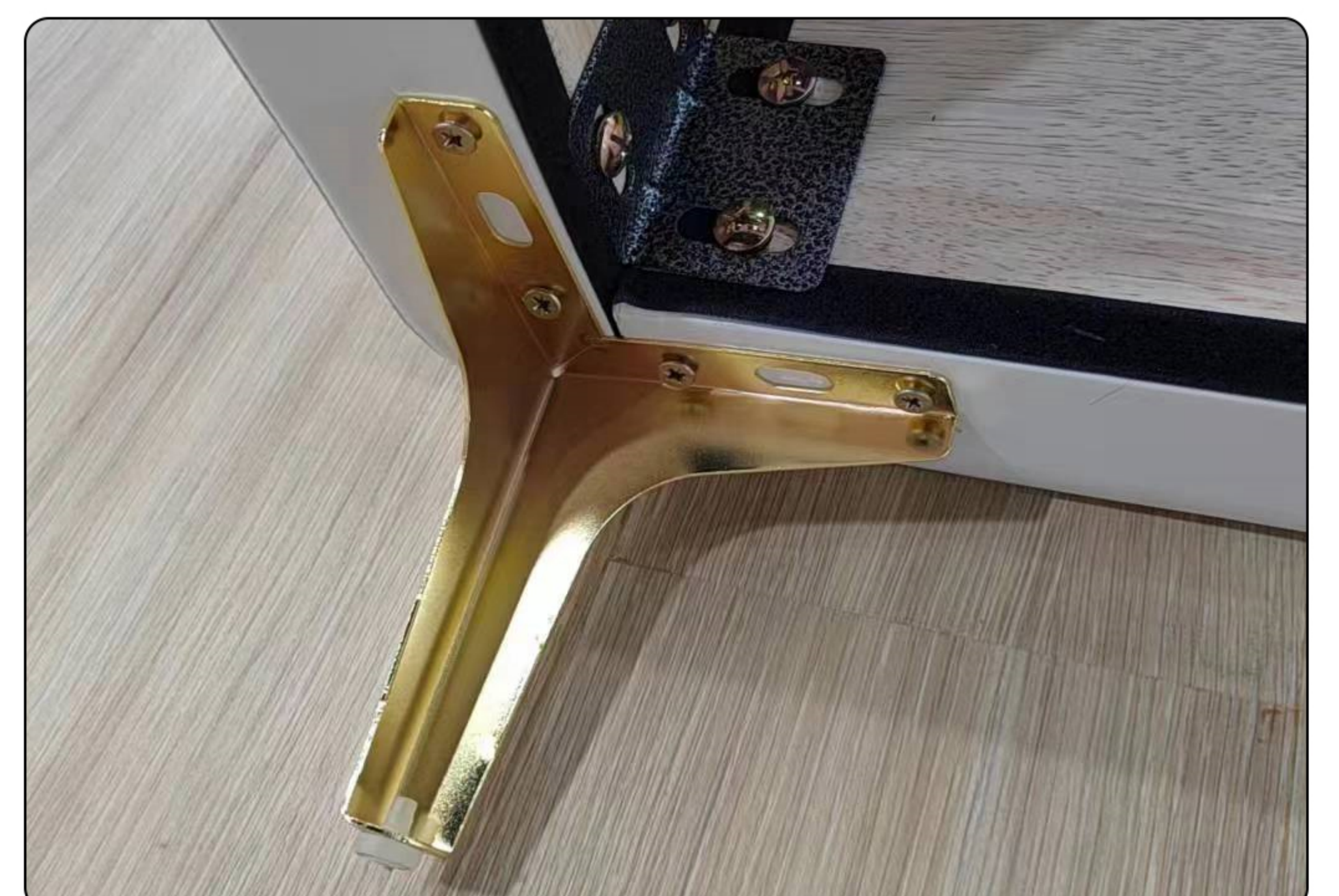
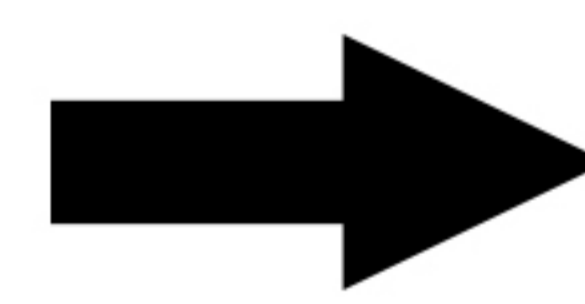

Step 7

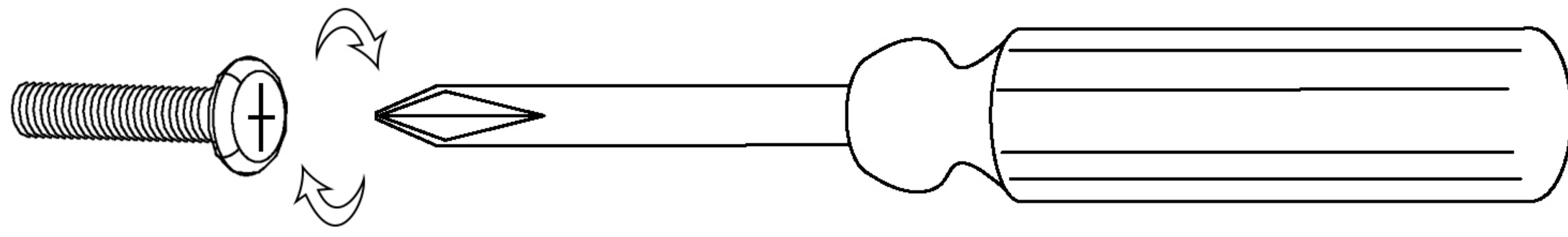

10



111X197-330mm
ADJUSTER FOOT-2 pcs

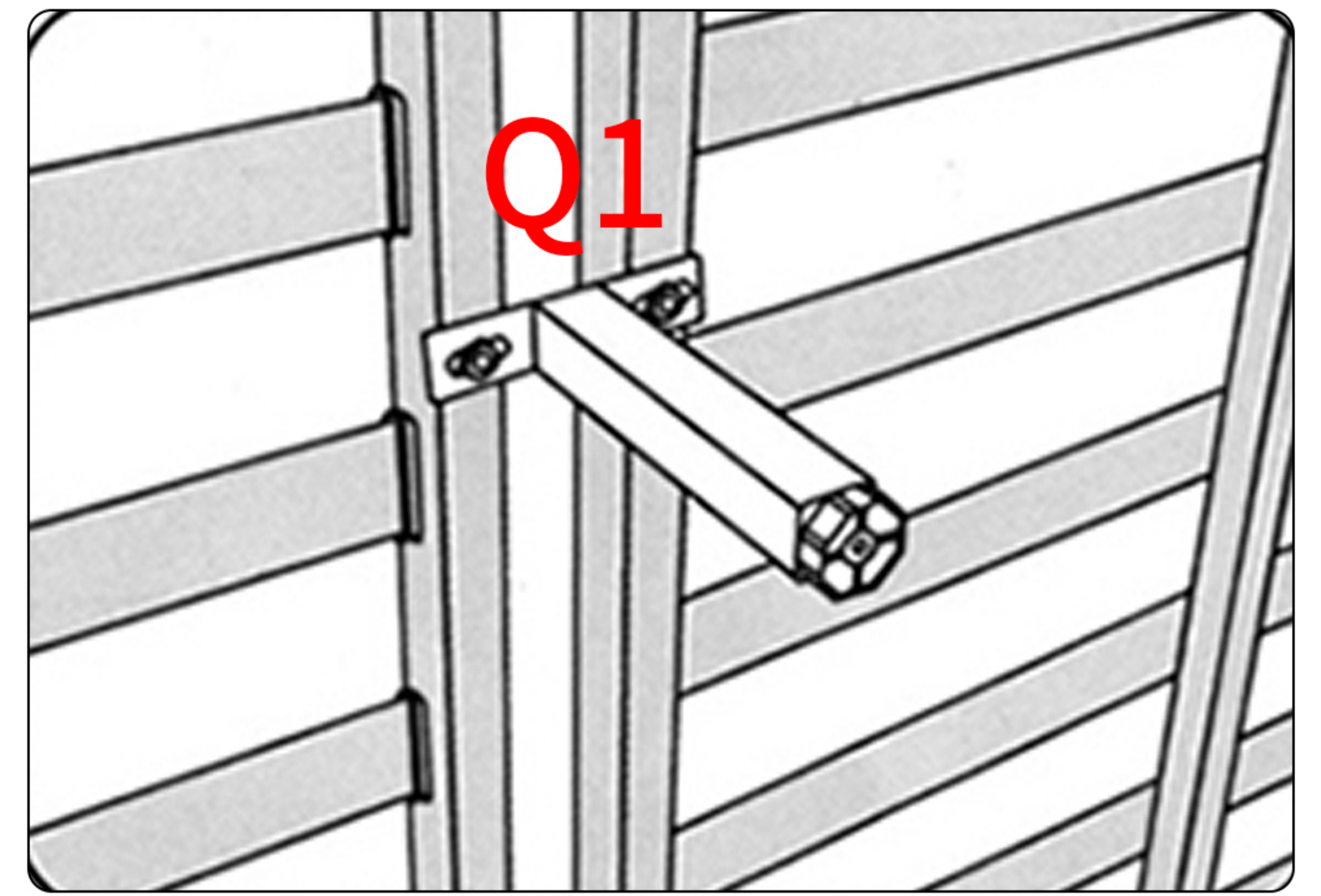
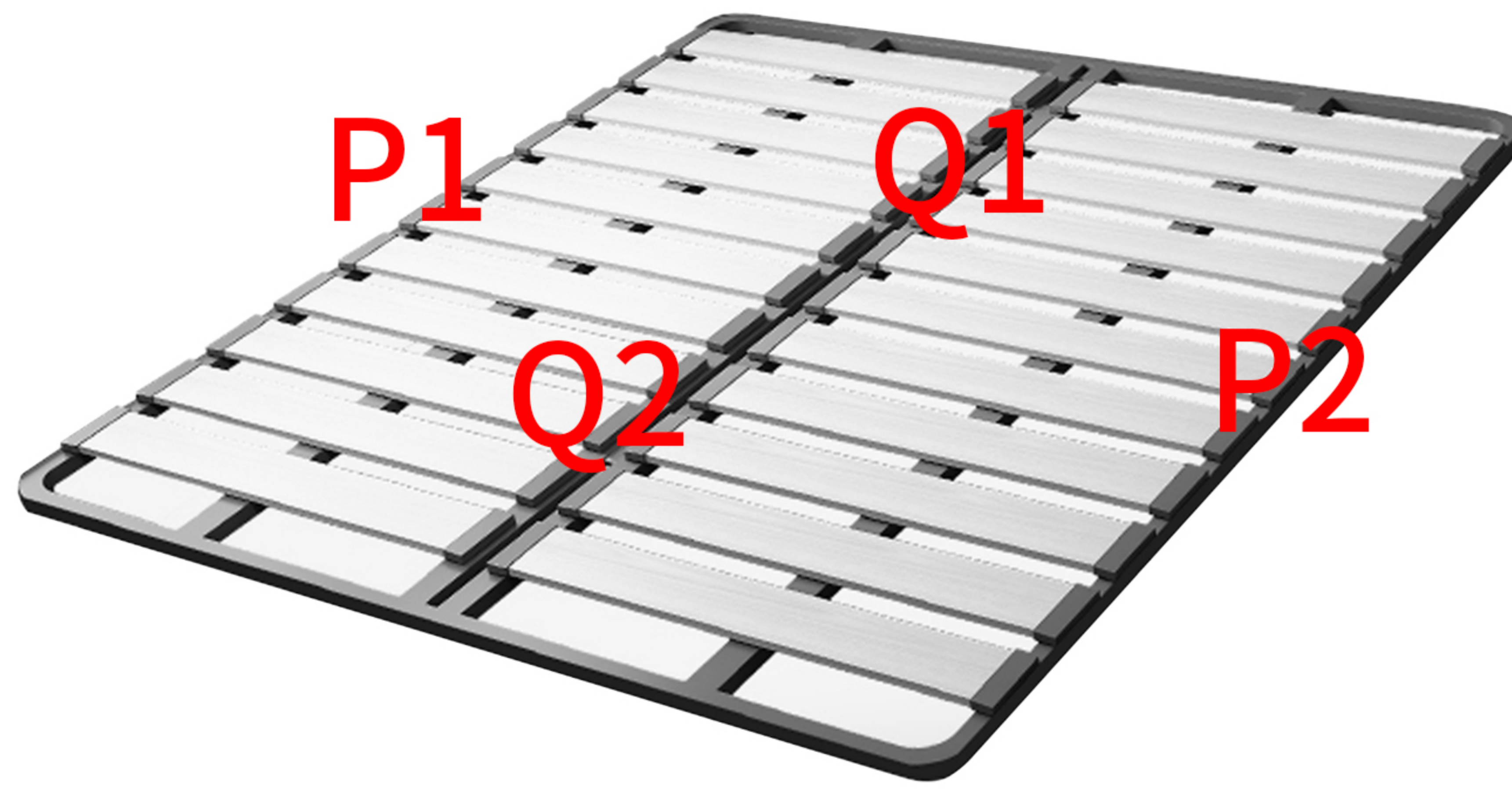

1

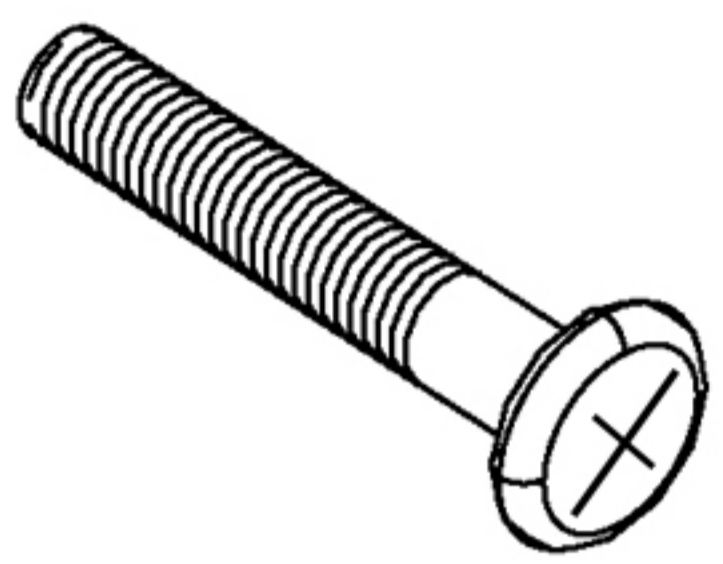

1/4" x 55 mm
Hex head bolts - 4 pcs

Rotate to adjust height:197-330mm



4

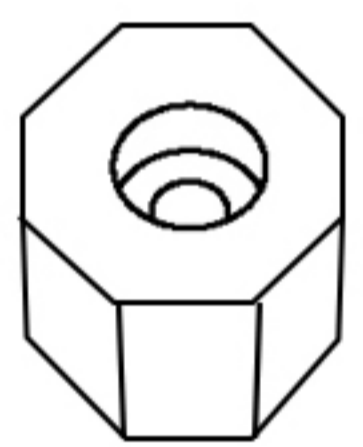

connecting bar - 4 pcs

Step 8

Rotate to adjust height:197-330mm

1

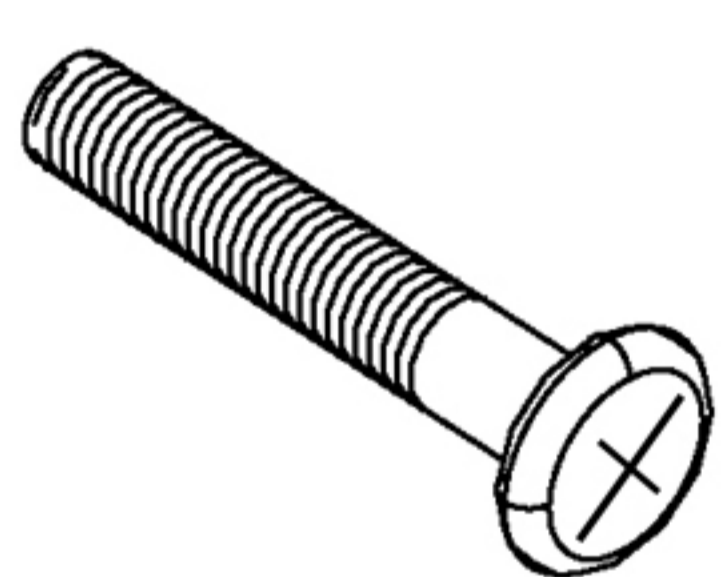

1/4" x 55 mm
Hex head bolts - 2 pcs



11



45X197-330mm
ADJUSTER FOOT-2 pcs



Step 9

STICK SILENT COTTON PADS ON ALL FOUR CORNERS

5



Ø 25X3mm
Mute pad-10 pcs



JUST PUT THE INSTALLED ROW FRAMEWORK ON TOP AND IT'S DONE

Step 10

