

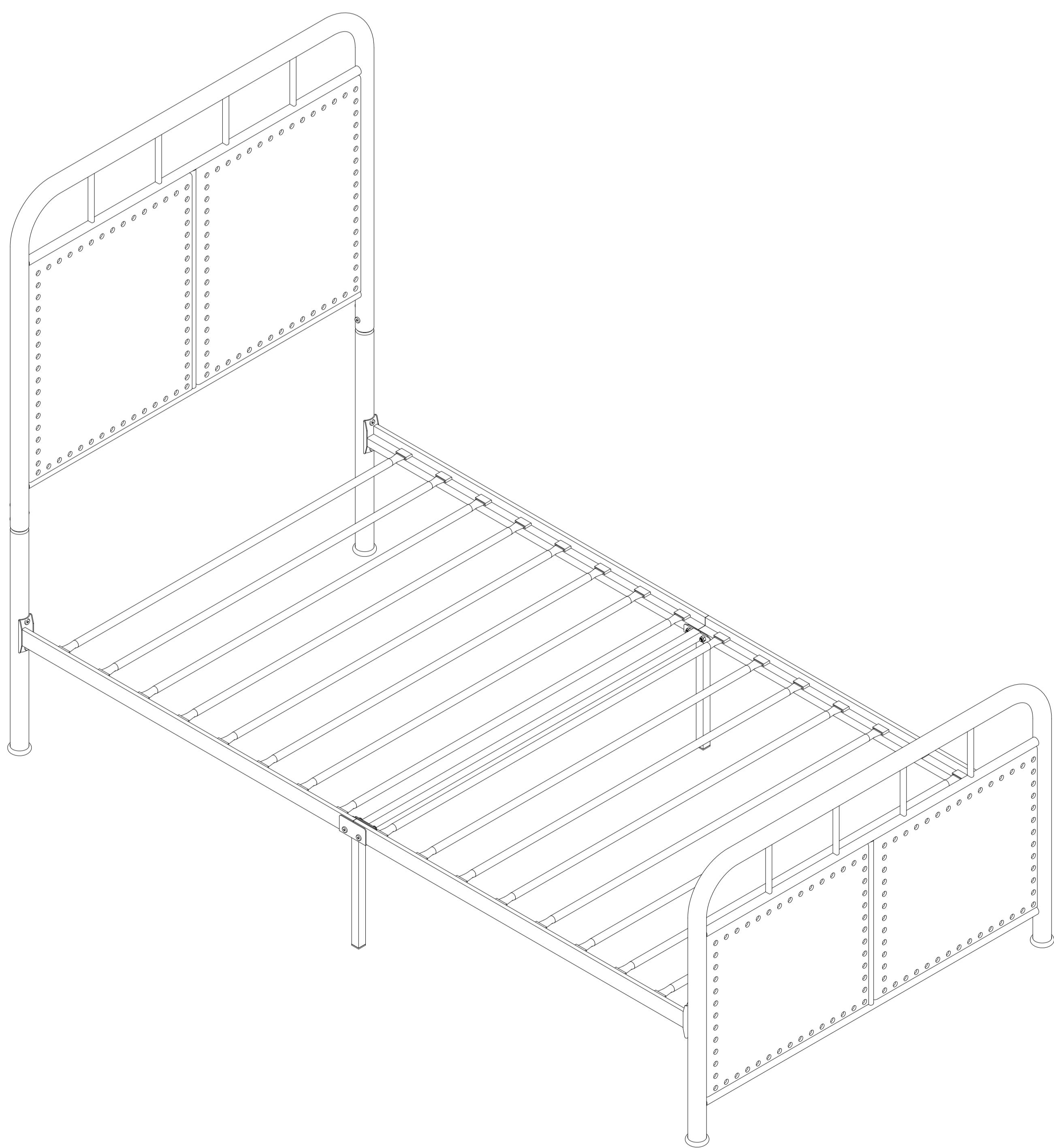

**PARTS&HARDWARE LIST**

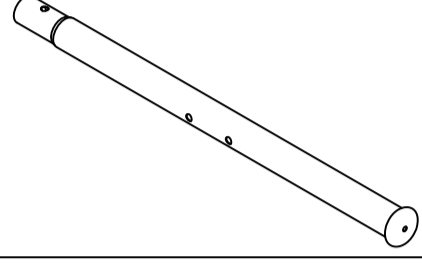
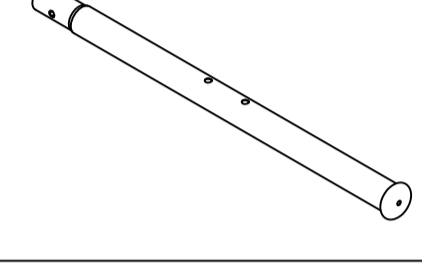
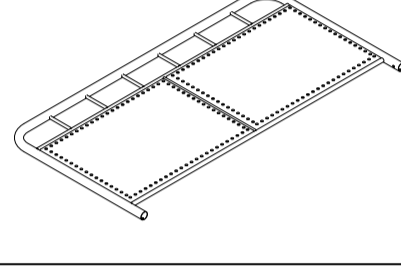
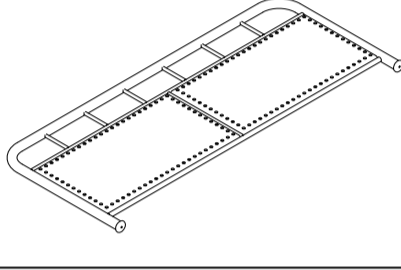
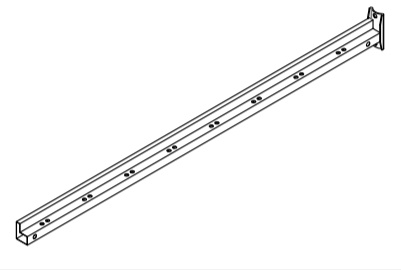
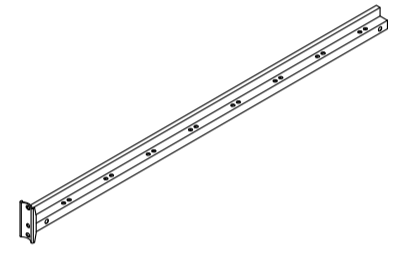
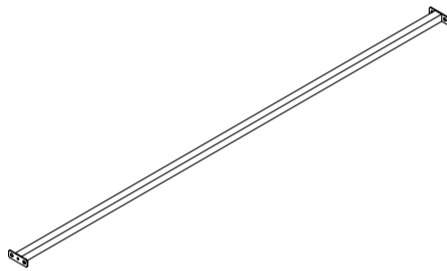
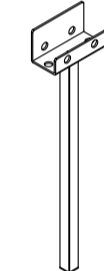
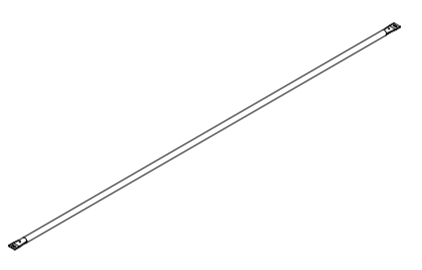
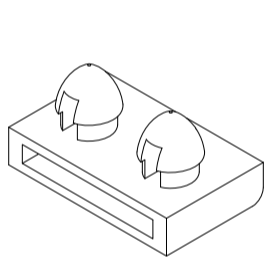
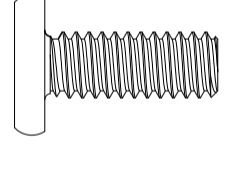
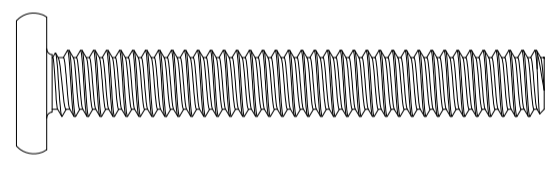
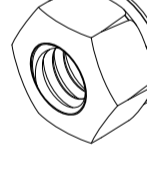

<b>A</b>		HEADBOARD LEG	1PC
<b>B</b>		FOOTBOARD LEG	1PC
<b>C</b>		HEADBOARD	1PC
<b>D</b>		FOOTBOARD	1PC
<b>E</b>		RAIL SECTION	2PCS
<b>F</b>		RAIL SECTION	2PCS
<b>G</b>		CENTER SUPPORT BAR	1PC
<b>H</b>		RAIL SUPPORT LEGS	2PCS
<b>I</b>		SLAT	16PCS
<b>J</b>		SLAT CAP	32PCS
<b>1</b>		BOLT 1/4" X 16MM	18PCS
<b>2</b>		BOLT 1/4" X 46MM	4PCS
<b>3</b>		NUT 1/4"	4PCS
<b>4</b>		L-ALLEN-KEYM4	1PC
<b>5</b>		WRENCH	1PC

**IMPORTANT NOTE:PLEASE NOT TIGHTEN ANY BOLTS UNTIL ALL OF THEM ARE PUT IN PLACES THEN TIGHTEN THE BOLTS.**

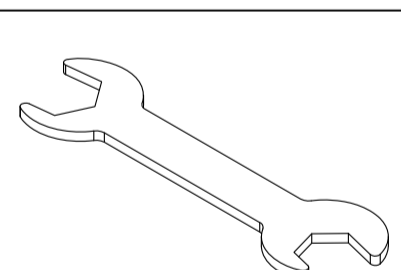
# STEP 1

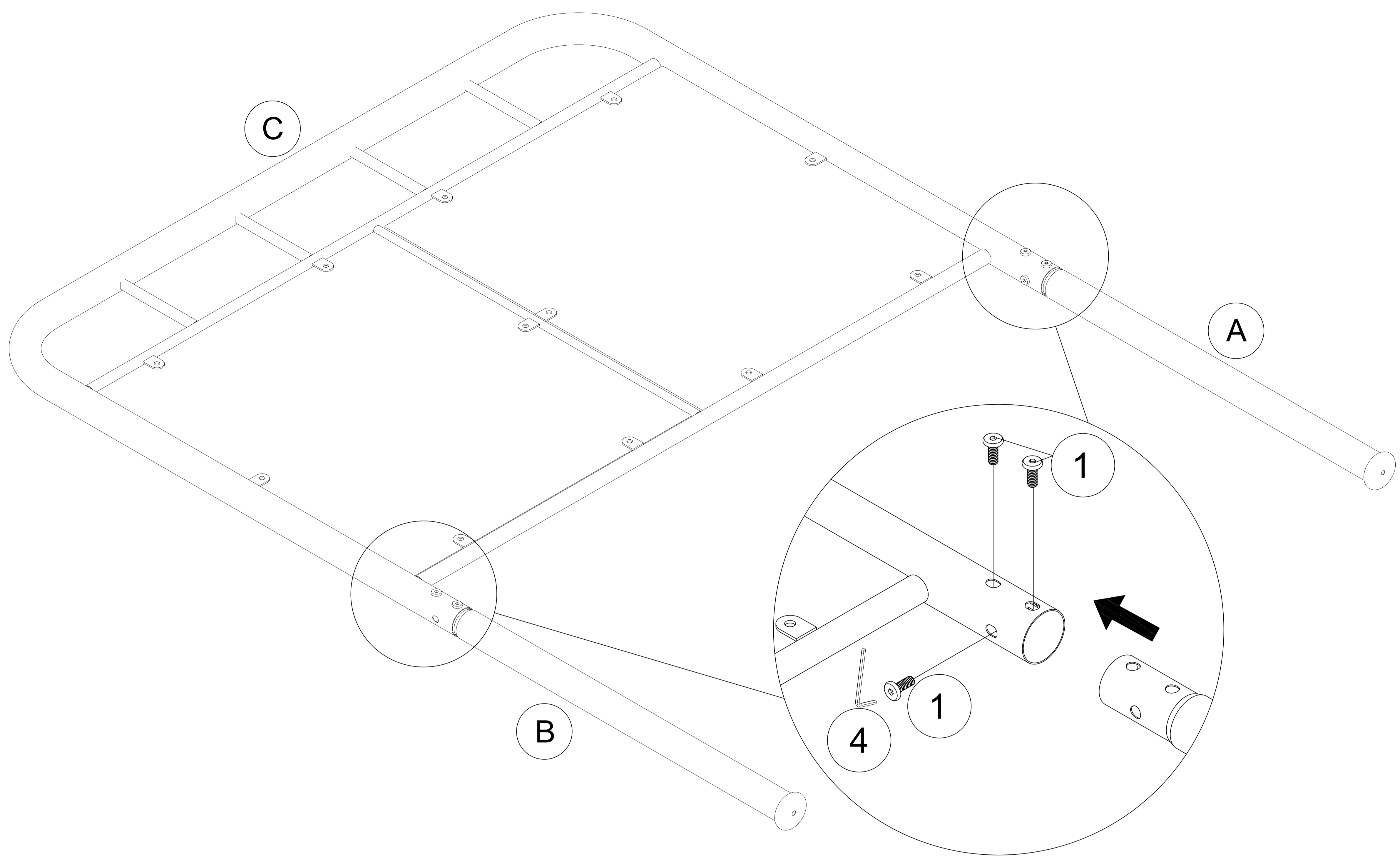

# STEP 2

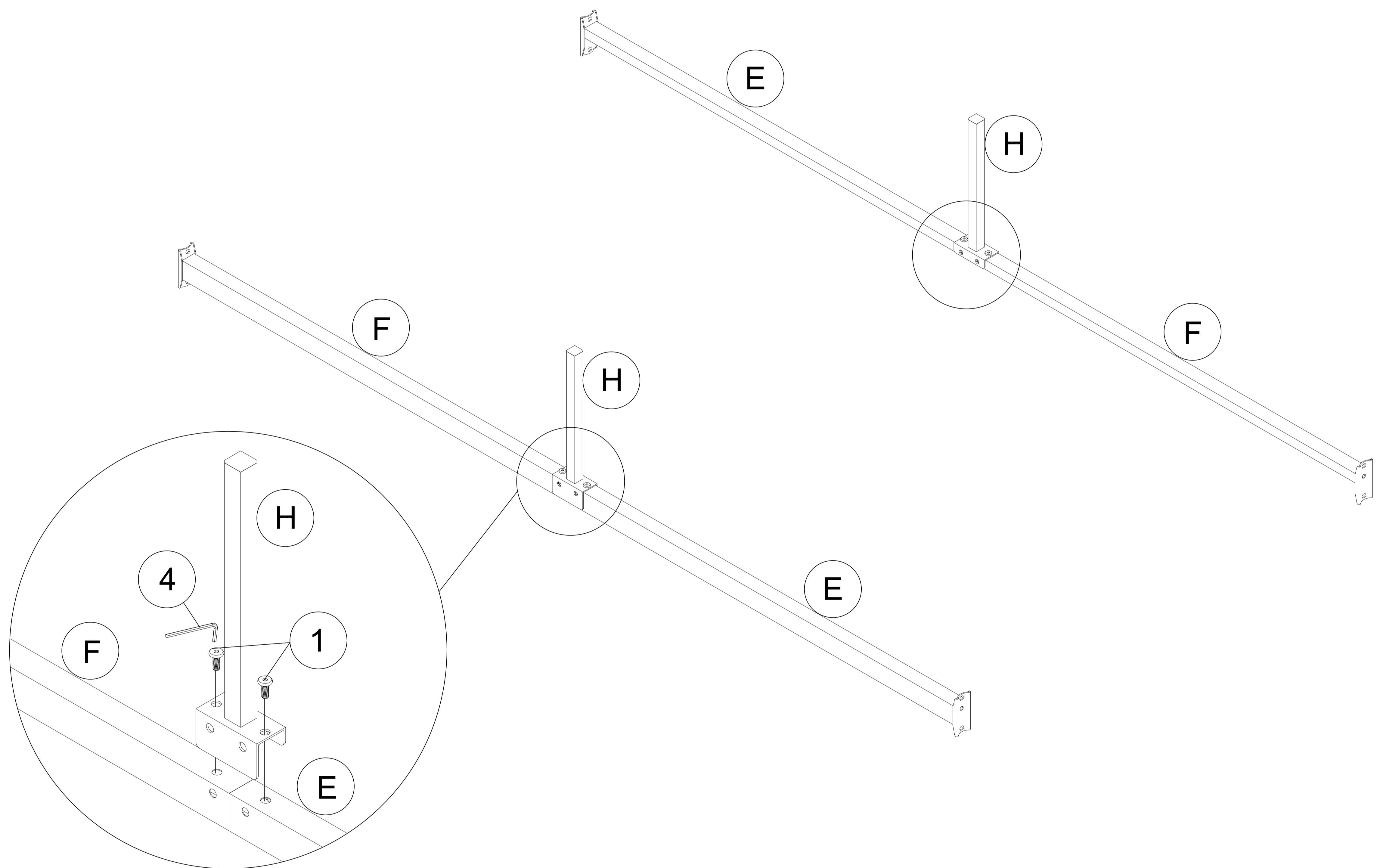

# STEP 3

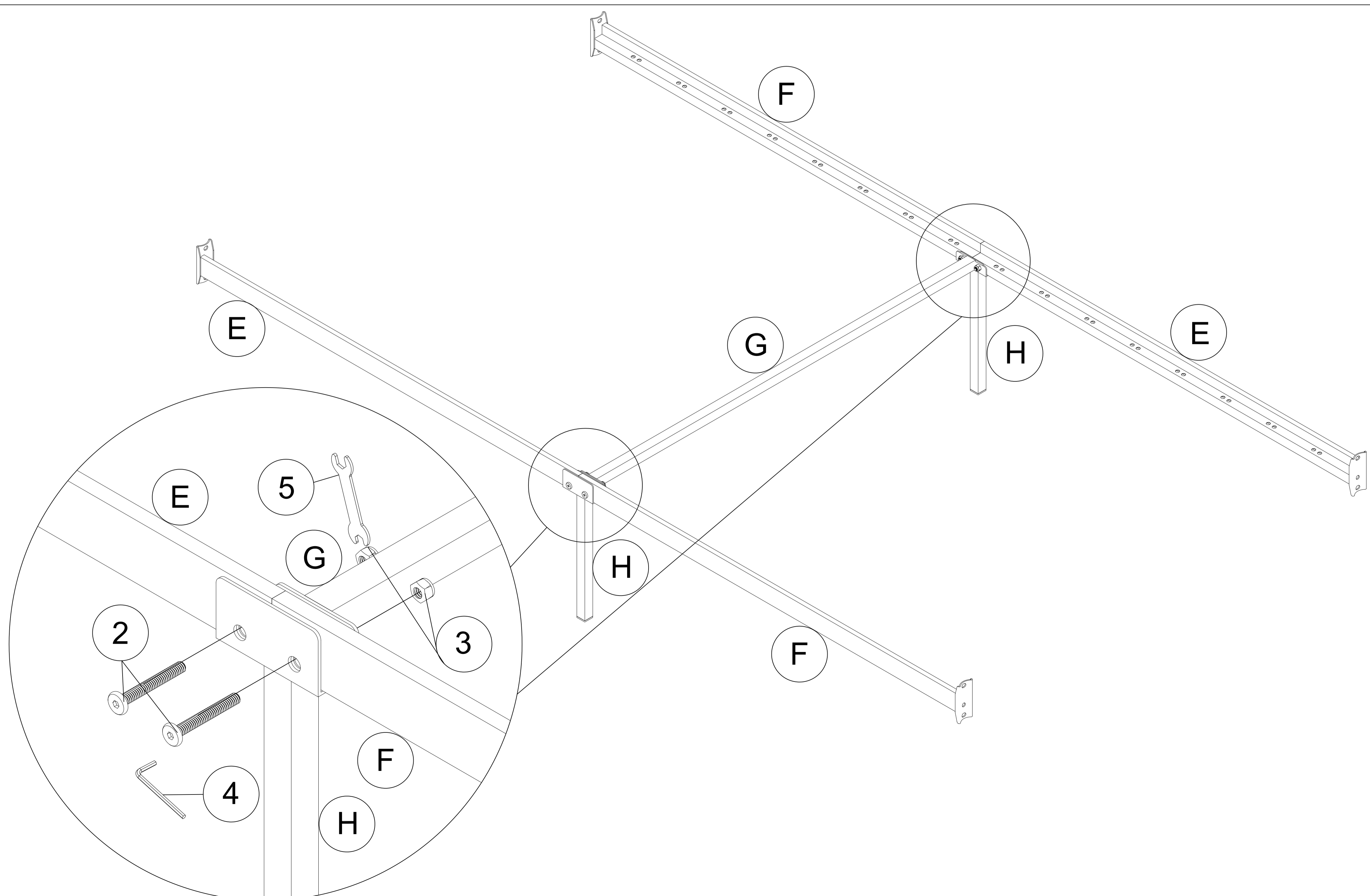

# STEP 4

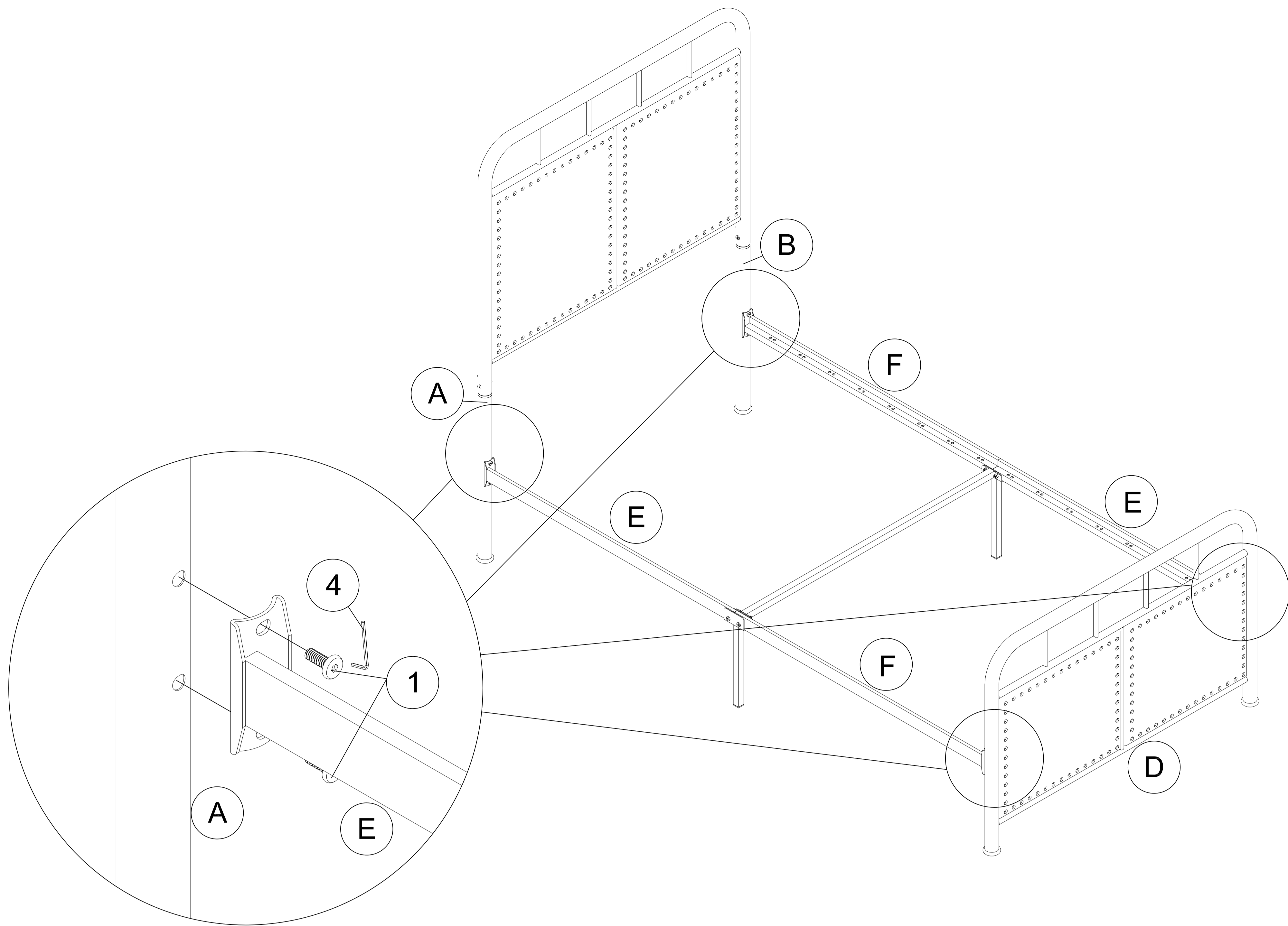

# STEP 5

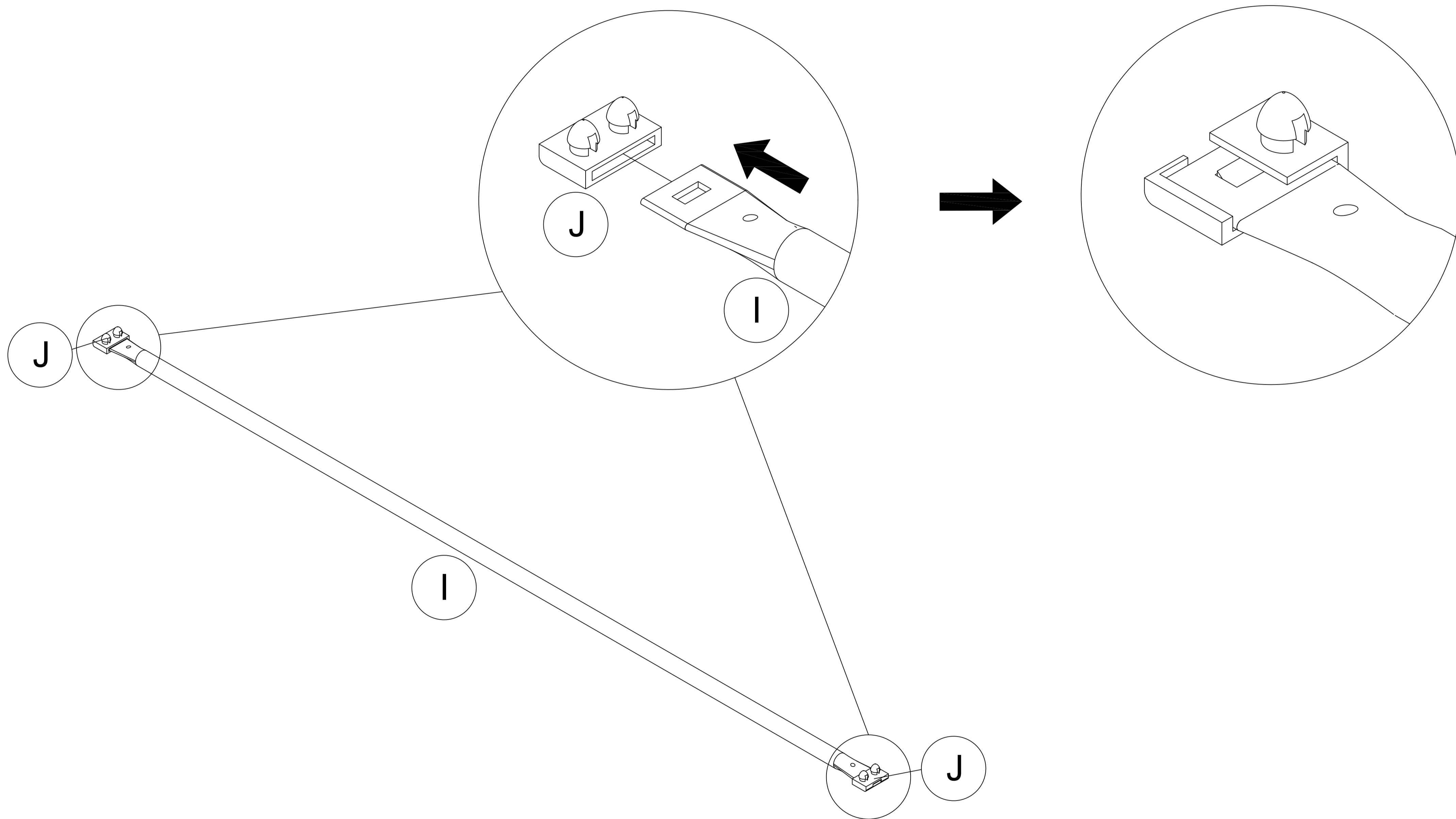

# STEP 6

# COMPLETED

